

Tilt-Turn Window INSTALLATION

1.) You Will Need to Supply

- Safety Glasses - Hearing Protection
- Level - Square
- Hammer –
Wood Shims
- Insulation –
Tape Measure
- Perimeter Sealant –
2” Roofing Nails
- Sill Pan Flashing –
Power Drill
- Backing Material (Foam Backing Rod)
- Flashing Materials
- Weather Resistant Barrier

1. Inspect the Opening

Check the opening for plumb, level, and square. Make sure the rough opening sill is level. Rough opening should be 3/4"-1" larger than window frame.

2. Inspect the Tilt-Turn(window).

Premeasure window to be sure window will fit into opening.

3. Insert the Tilt-Turn (window) into the opening.

A. Place the window into the opening. Windows to have minimum 3/8"-1/2" shims under side frames and mullions. (Do not set window frame directly on RO sill.)

B. Use positioning fins to fit window in the proper plane. Positioning fins should sit flush onto exterior sheathing. It is not recommended that the fins be used as a nailer to fasten the window to the sheathing at this time, fins to be fastened after window is fully adjusted.

C. Install shims and installation screws, then check that the alignment of the sash and frame is consistent around the perimeter. Check operation of the sash. Window can be adjusted for proper alignment by adjusting shim size and tightening and loosening opposing mounting screws at top of sides. Make sure not to over shim or overtighten mounting screws so that the frame sides or top/bottom bend or bow. Make sure the sash simultaneously touches the weather stripping on both sides of the frame when the window is closed.

D. Once the window is properly leveled, plumb and square fasten positioning fin to sheathing. Adhere foam corner pads on exterior surface where positioning fins meet at corners. Apply any necessary caulking to corner pads where they meet window frame.

E. Apply 6" window wrap (Vycor or similar) over positioning fin, being sure window wrap contacts aluminum frame. Be sure to overlap joints to shed water.

4. Clean window and glass.

5. Insert Screen onto Screen Plugs

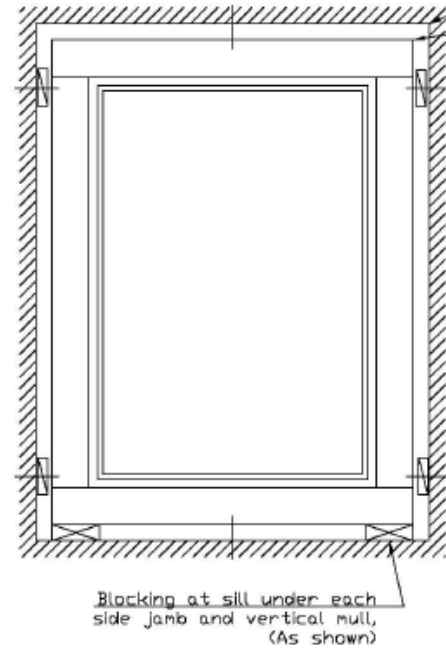

STUD WALL DETAIL

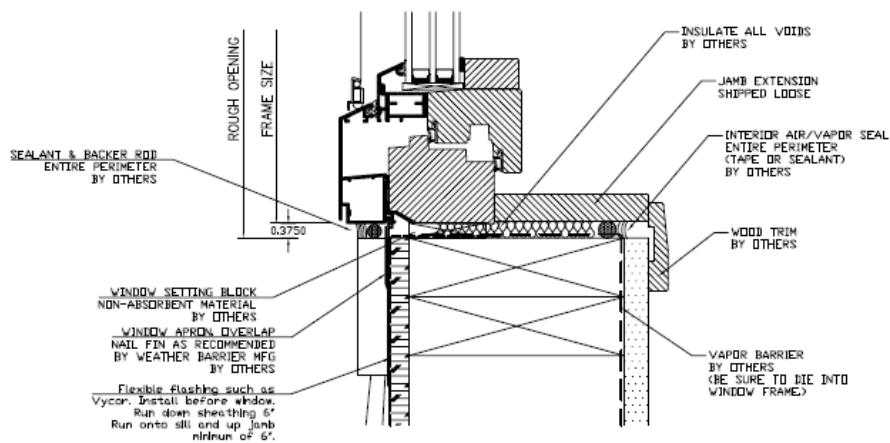
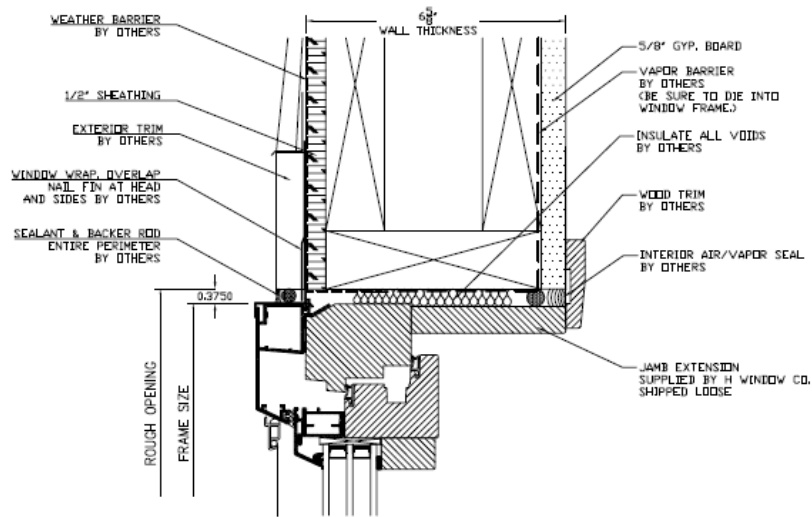
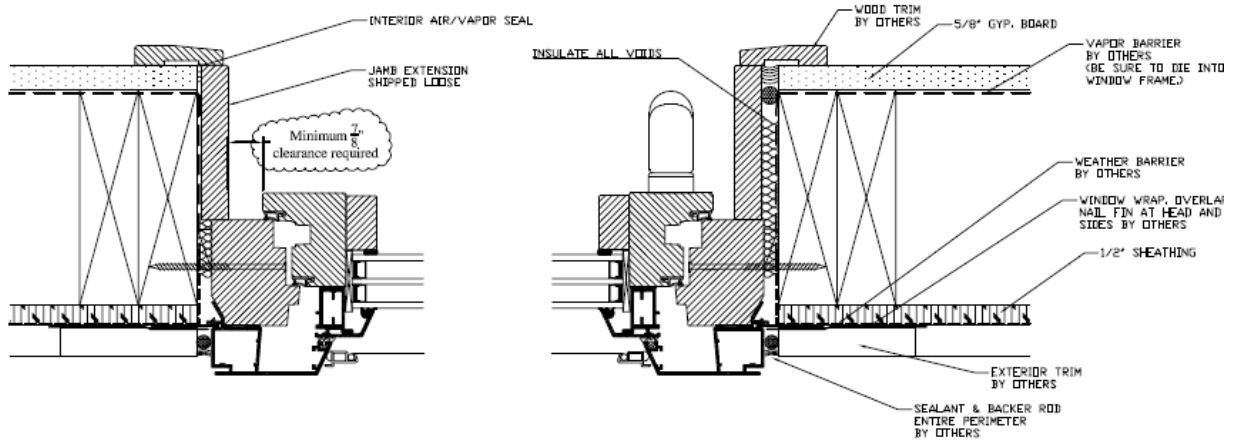

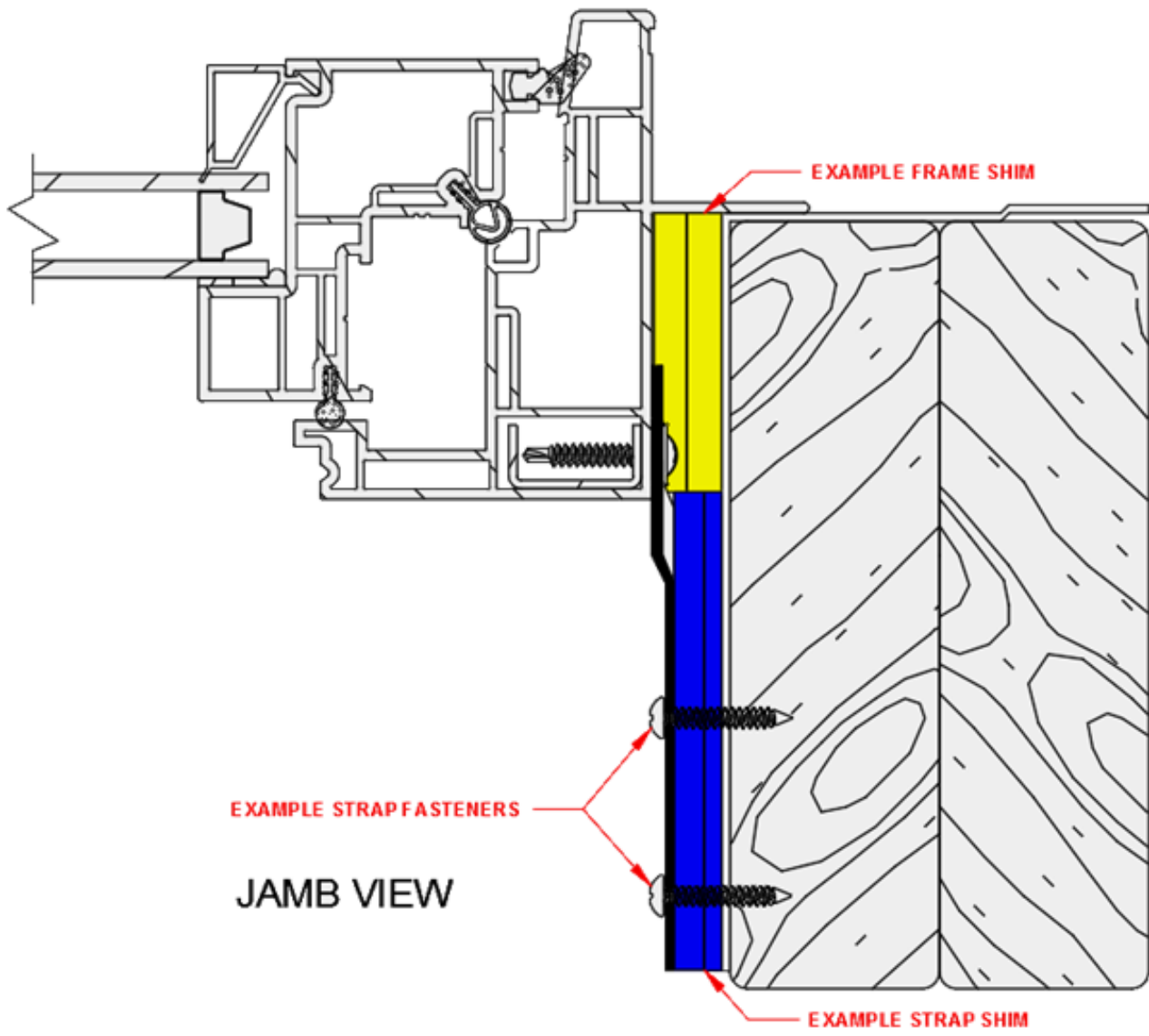

EXAMPLE STRAP FASTENERS

JAMB VIEW

EXAMPLE FRAME SHIM

EXAMPLE STRAP SHIM

BLOCK WALL DETAIL

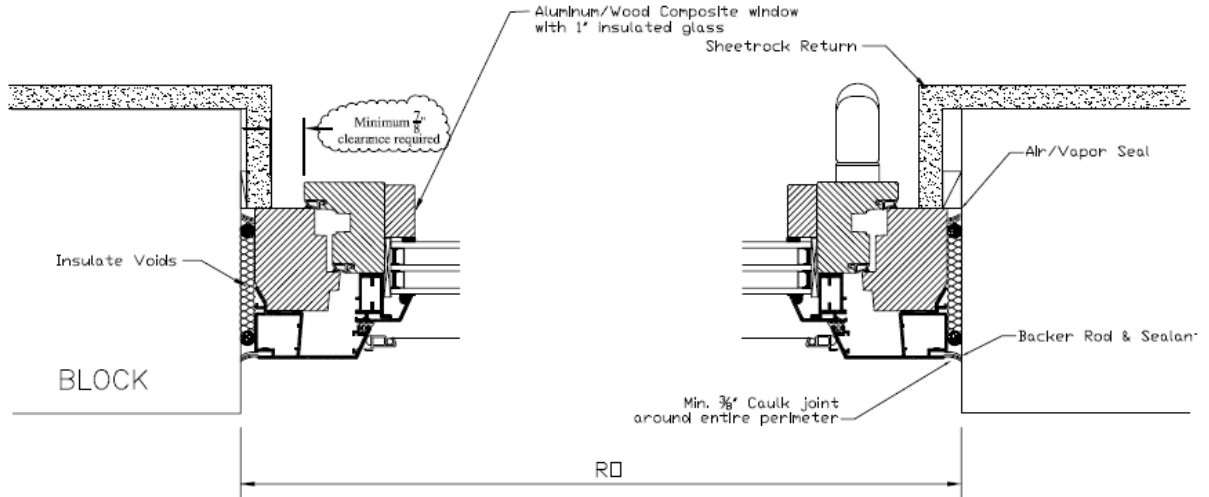

JAMB VIEW

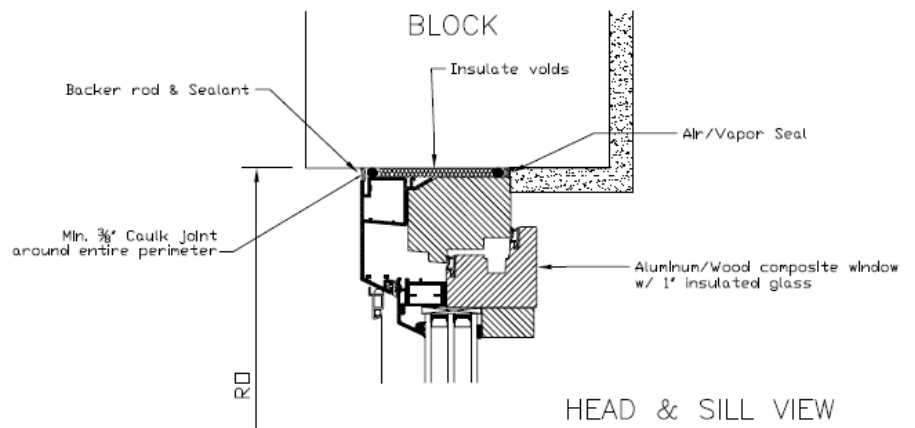

HEAD & SILL VIEW

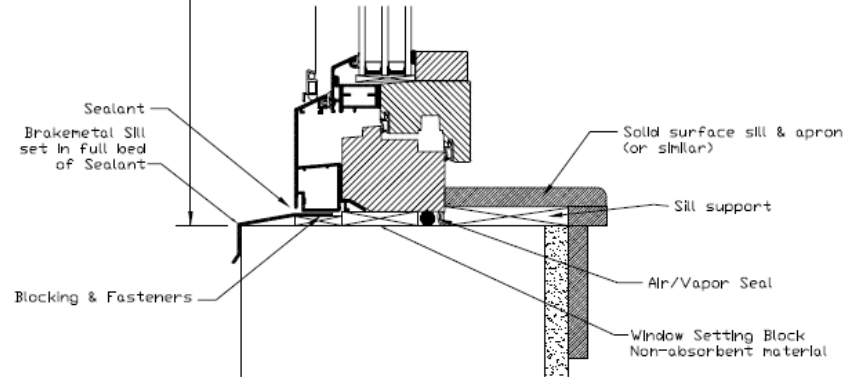

STUCCO WALL DETAIL

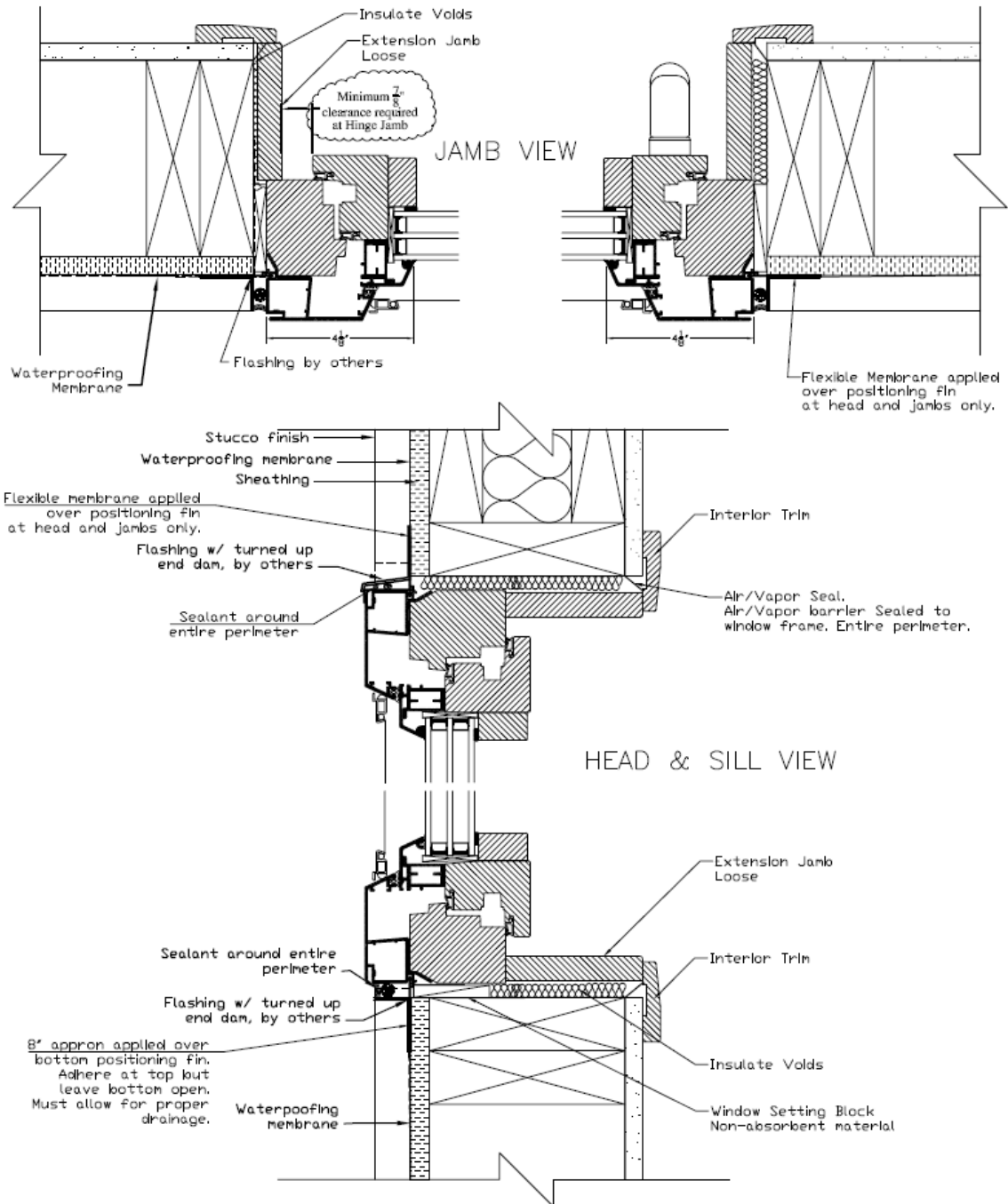

Important Note: THESE CROSS SECTIONS ARE GENERIC STUCCO WALL DETAILS. IT IS THE INSTALLERS RESPONSIBILITY TO CONFORM TO APPLICABLE CODES FOR STUCCO INSTALLATIONS AND TO ENSURE PROPER FLASHING, SEALING, AND VAPOR BARRIERS OF ALL OPENINGS.

PREPARING THE OPENING

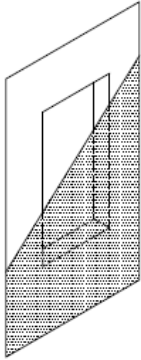

Step 1:
Apply continuous weather barrier over window opening.

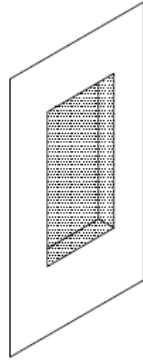

Step 2:
Cut out weather barrier that covers rough opening flush with edge of rough opening.

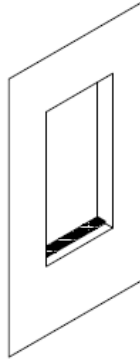

Step 3: (OPTIONAL)
Install plywood backdam to sill of rough opening.

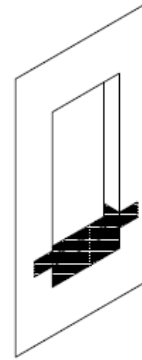

Step 4:
Install flexible flashing such as Vycor over plywood backdam and rough opening sill and extend down weather barrier 8" and min 6" up side jamb.

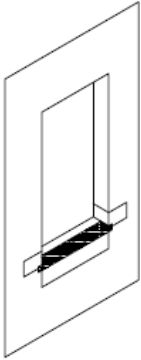

Step 5: (NOT REQUIRED)
Install optional Sill flashing such as Jamsill Guard or equivalent onto rough opening sill. Set in urethane sealant.

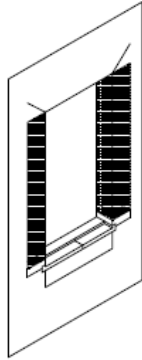

Step 6: (OPTIONAL, Verify with local codes.)
Install flexible flashing such as Vycor or equivalent onto rough jamb and extend over weather barrier 8". Make angular cuts in weather barrier at header as shown.

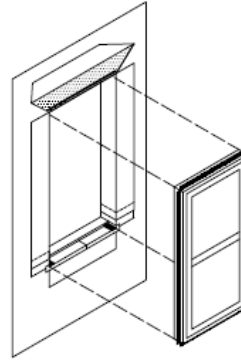

Step 7:
Install 1/2" non-absorbent window setting blocks at sill approx 1/2" from side jamb. Fold up previously scored weather barrier and apply bead of sealant at head where positioning fin will come into contact. Ensure that the Jamsill Guard is allowed to shed water behind positioning fin at sill. Install Window square, level and plumb per manufacturers specifications and installation details. Be sure the positioning fin lays flat and is in contact with flexible flashing.

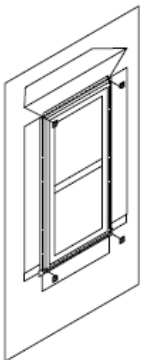

Step 8:
After window unit is properly installed, install foam corner pads and apply bead of sealant where corner pads contacts window frame. Staple nail fins around perimeter of unit.

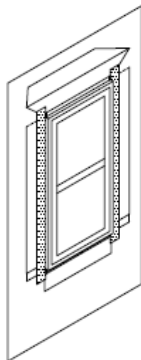

Step 9:
Install flexible flashing such as Vycor or equivalent over jamb positioning fin. Extend above and below Step 6 flexible flashing. Do not apply flexible flashing over positioning fin at sill so water is allowed to escape.

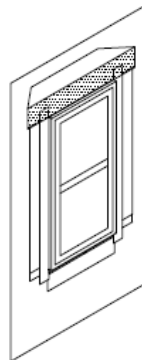

Step 10:
Install flexible flashing such as Vycor or equivalent over head positioning fin. Extend beyond Step 6 flexible flashing.

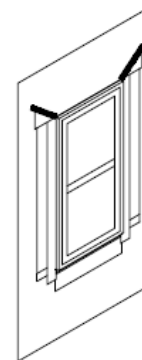

Step 11:
Fold weather barrier back down and tape seams.