



T900

—



Grade 2 Tubular Locksets



CONTENTS

| | | |
|--------------------------|-------------------------------|---|
| Grade 2 Tubular Locksets | Features | 3 |
| | Technical Details | 3 |
| | How to Order | 4 |
| Trim Designs | T900 Standard Levers | 4 |
| | T900 Premium Levers | 5 |
| | Wrought Roses | 5 |
| Functions | Available Functions | 6 |
| Lock Options | 1/2" Throw Tubular Latch Bolt | 7 |
| | T-Strike | 7 |
| | Full Lip Strike | 7 |
| | 4-7/8" Strike | 7 |

DORMA USA quality and environmental management systems in Reamstown, PA and Steeleville, IL are certified to ISO 9001:2008 and ISO 14001:2004.



LD Lever



LR Lever



L114 Lever

T900 – GRADE 2 TUBULAR LOCKSETS

Enhanced aesthetics and rugged dependability for demanding interior applications.

Designed to blend with M9000 lever locks, the T900 Series is easy to install with preassembled trim and the quality you expect from DORMA. T900 Series locksets will meet and exceed the expectations of the most demanding architects and design professionals.

Features

- DORMA T900 Series locks feature matching lever designs to the M9000 mortise locks, providing exceptional reliability, and are manufactured with the finest material, delivering enhanced durability.
- T900 locks are easy to install in both wood or hollow metal doors with ANSI/BHMA A156.115 preparations for bored locks.
- Lever trims include auxiliary support springs to ensure smooth operation and long life.
- Standard door thickness ranges from 1-3/8" (35 mm) to 1-3/4" (44 mm) thick.
- Available with a 2-3/4" (70 mm) backset standard. Optional 2-3/8" (60 mm) backset available.
- Latch bolt projection is 1/2" (13 mm). The 2-3/4" (70 mm) backset latch is furnished standard with square corner front, 1-1/8" x 2-1/4" (29 mm x 57 mm) faceplate. The 2-3/8" (60 mm) backset latch is furnished standard with square corner front, 1" x 2-1/4" (25 mm x 57 mm) faceplate.

Recommended Interior Applications

- Hotel Guest Rooms
- High-End Apartments
- Condominiums
- Office Buildings
- Home Offices

Technical Details

- Non-handed chassis (excluding select lever styles).
- Optional UL/CUL model for use on 3-hour fire-rated doors and for all positive pressure applications.
- Premium PVD (physical vapor deposition) finishes used on 605, 606, 612, 613, 619 for consistent durable color.

Certification/Compliance

T900 Series levers designs meet A117.1 accessibility code and ADA requirements for barrier-free accessibility.



UL/CUL – UL 10C Positive Pressure (optional)

T900 Series locks are available with latch bolts meeting the requirements of UL 10C and listed for use on B label fire doors rated up to 3 hour and lesser class single doors, 4'0" x 8'0" maximum. Upgrade available on T910 and T925 functions only.



Warranty

For details, refer to **DORMA Limited Warranty** on our website at go.dorma.com/terms.

Finishes

- Brass: 605 PVD (Bright) or 606 PVD (Satin).
- Bronze: 612 PVD (Satin) or 613 PVD (Dark Oxidized Satin).
- Nickel: 619 PVD (Satin).
- Chrome: 625 (Bright) or 626 (Satin).
- Stainless: 629 (Bright) or 630 (Satin).

NOTE: Consult factory for finishes not shown.

Antimicrobial Protected Coating: Specify AM.

Special Finish Notes:

ANSI/BHMA A156.18 standards describe 613 Dark Oxidized Satin Bronze finish as a category B finish. B category finishes, "do not match from one alloy or form of material to the next and from one manufacturer to the next." The 613 finish may vary between manufacturers' products and models.

In some instances, for customer convenience, the most appropriate BHMA finish symbols are used to indicate similarity of appearance, regardless of base metal or finishing process. Finishes of latches, strikes, cylinders/cores, and visible mounting screws, though similar in appearance, may differ from the finish of the trim. Finish designations in the 600 numbers are the BHMA (Builders Hardware Manufacturers Association) industry standard.

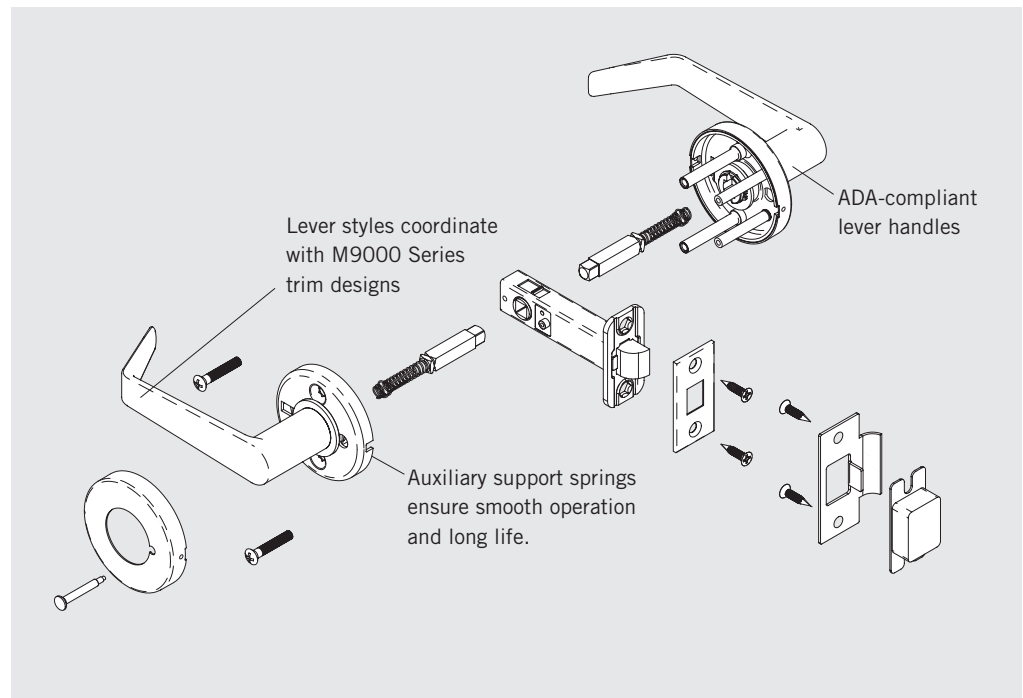

HOW TO ORDER T900 SERIES LOCKS

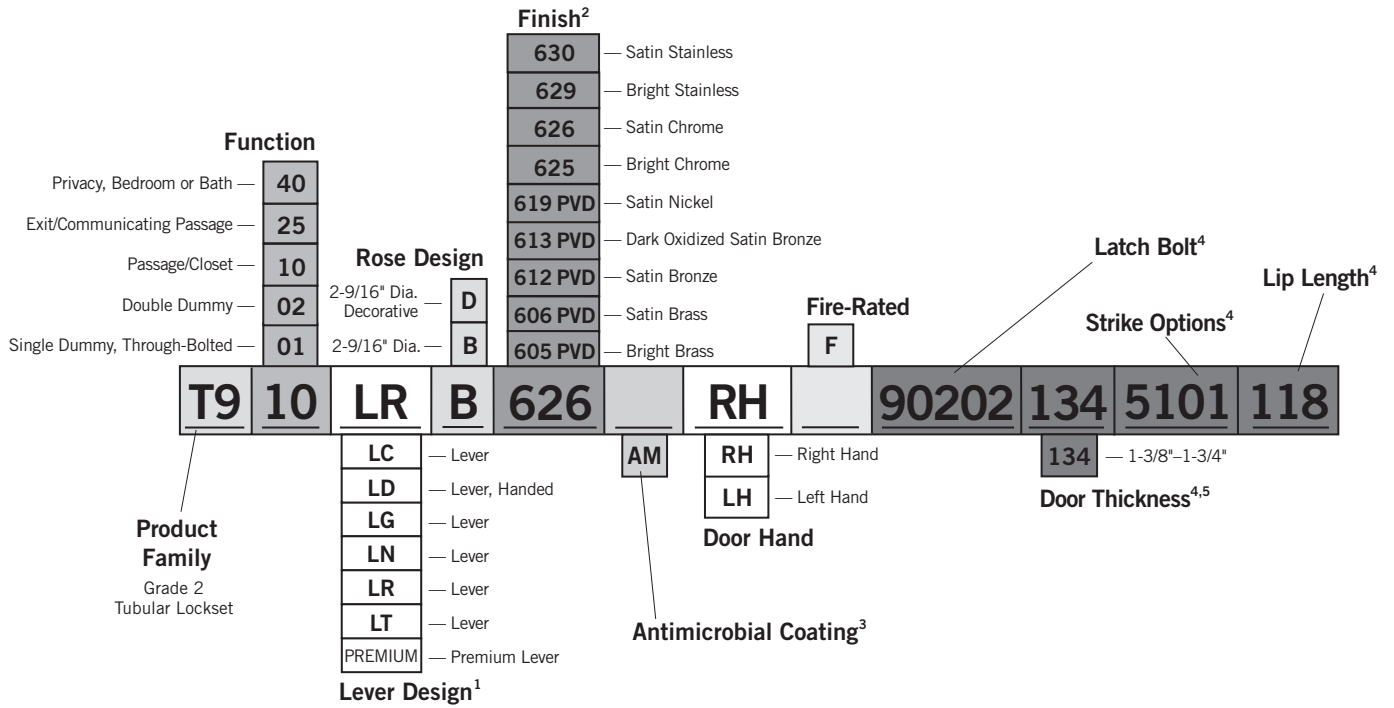

1. Select premium levers not available in 625 or 626. Use 629 or 630 as an alternative.
2. For split finishes, available on levers only, consult factory. Specify hand.
3. Available on 626/630 finishes only. Consult factory for other finishes.
4. Example shows default values. Refer to Lock Options section for full details.
5. Standard door thickness is 1-3/8"-1-3/4". Contact factory for other thicknesses.

TRIM OPTIONS

Standard Levers

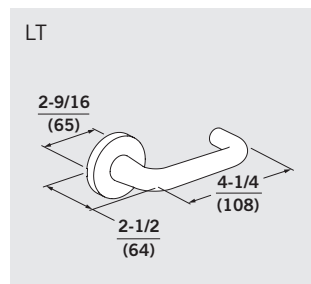
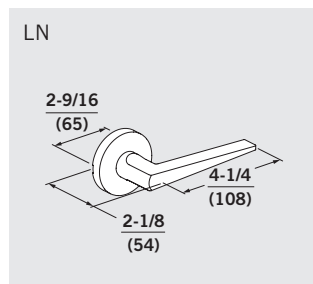
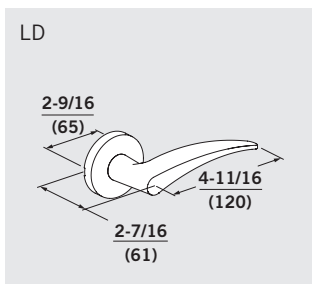
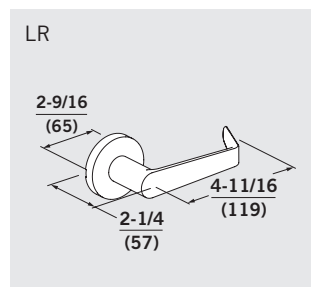
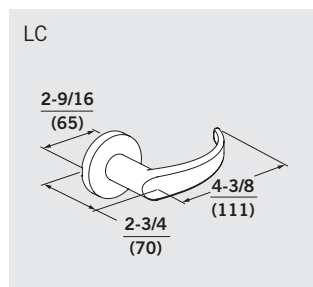
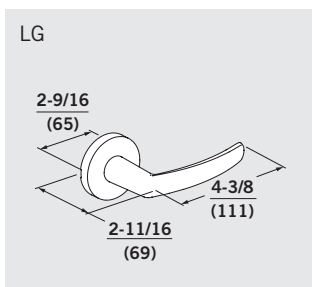

Premium Levers

(may require additional lead time)

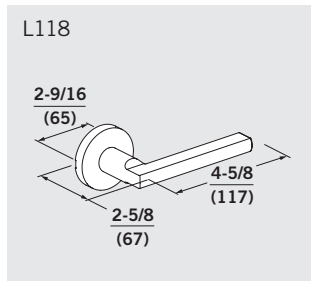
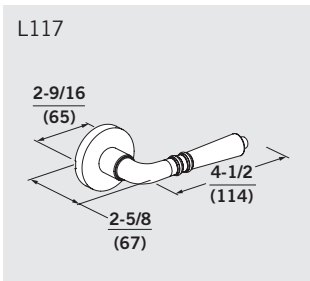
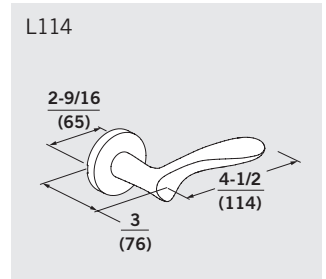
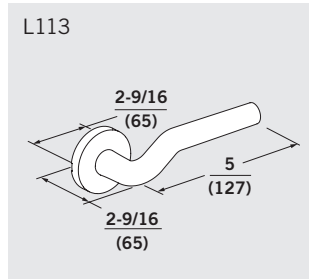
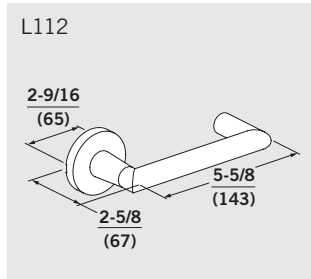
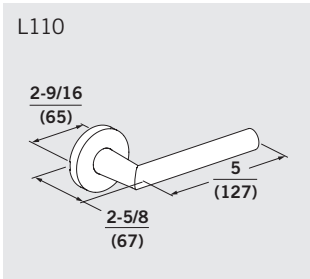
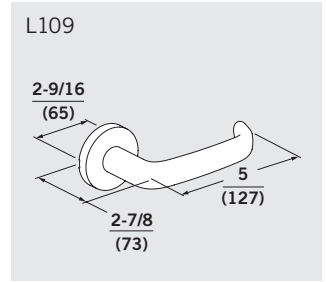
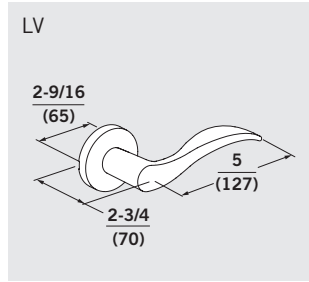
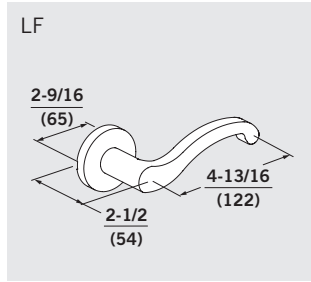
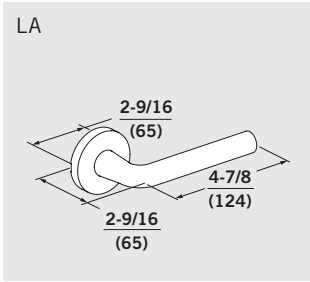

Wrought Roses

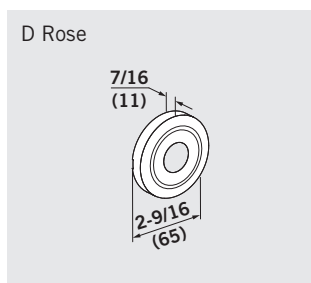
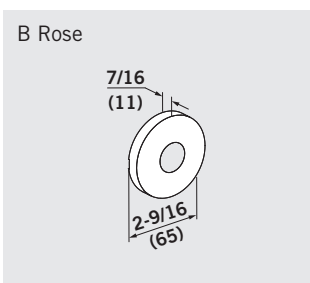

FUNCTIONS

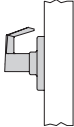
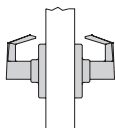
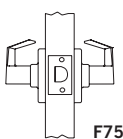
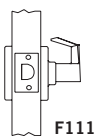
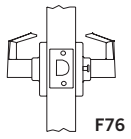
| Function | Series | Outside/Inside | Description |
|-------------------------------|--------|---|---|
| Dummy Trim One Side | T901 |  | <ul style="list-style-type: none"> Used as pull or matching trim on pairs of doors. For wood or custom hollow metal doors. Trim is through-bolted. |
| Dummy Trim Two Sides | T902 |  | <ul style="list-style-type: none"> Used as pull or matching trim on pairs of doors. For wood or custom hollow metal doors. Trim through-bolted. |
| Passage/Closet | T910 |  F75 | <ul style="list-style-type: none"> Latch bolt operated by trim either side at all times. |
| Exit/Communicating Passage | T925 |  F111 | <ul style="list-style-type: none"> Latch bolt operated by inside trim. Blank plate outside. Minimum clearance 1/2" on single doors and 1" between communicating doors. |
| Privacy, Bedroom or Bath | T940 |  F76 | <ul style="list-style-type: none"> Latch bolt operated by trim either side. Outside trim locked by push button inside. Outside trim unlocked by emergency release outside. Outside trim unlocked by trim inside. Outside trim unlocked by closing door. Inside trim always operates latch bolt. |



Indicates rigid or inoperable lever.

LOCK OPTIONS

1/2" Throw Tubular Latch Bolt

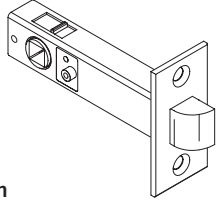
| DORMA Function | Part Number | | | |
|---|--|--|--|--|
| | 2-3/4" Backset 1-1/8"W × 2-1/4"H Square Corner | 2-3/4" Backset 1"W × 2-1/4"H Square Corner | 2-3/8" Backset 1"W × 2-1/4"H Square Corner | 2-3/8" Backset 1"W × 2-1/4"H Radius Corner |
|  | | | | |
| Non-Fire | | | | |
| T910—Passage/Closet, Non-Fire | 90202 | 90200 | 90100 | 90101 |
| T925—Exit/Communicating Passage, Non-Fire | 90202 | 90200 | 90100 | 90101 |
| T940—Privacy, Bedroom, or Bath, Non-Fire | 90232 | 90230 | 90130 | 90131 |
| T901—Dummy Trim One Side | N/A | N/A | N/A | N/A |
| T902—Dummy Trim Two Sides | N/A | N/A | N/A | N/A |
| Fire-Rated* | | | | |
| T910—Passage/Closet, 3 Hour Fire-Rated | 91202 | 91200 | 91100 | 91101 |
| T925—Exit/Communicating Passage, 3 Hour Fire-Rated | 91202 | 91200 | 91100 | 91101 |
| T940—Privacy, Bedroom, or Bath, Fire-Rated | N/A | N/A | N/A | N/A |

NOTE: Default latches shown in bold, shipped with all T900 Series locksets unless specified otherwise. 2-3/4" is standard backset.

* Fire-rated latches only work with locks originally ordered as fire-rated.

Strikes

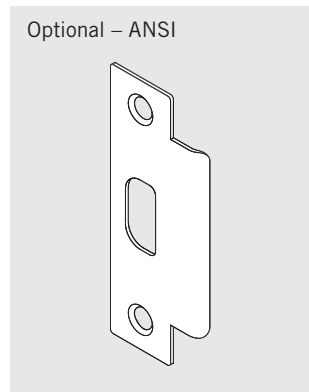
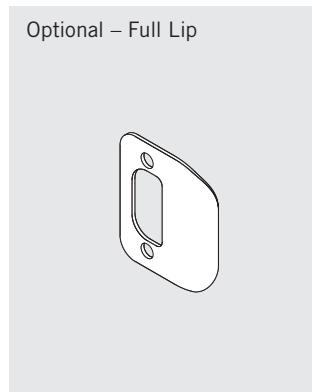
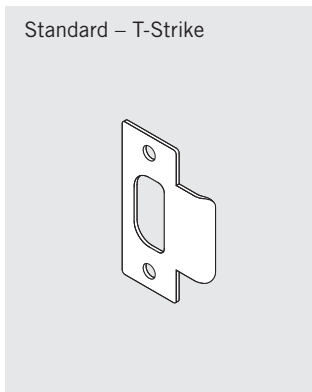

Dust box included.

5101—1-1/8" × 2-3/4" square T-strike. 1-1/8" lip length. Default strike for all T900 Series locks.

5102—1-1/8" × 2-3/4" T-strike with radiused corners. 1-1/8" lip length. Optional for all T900 Series locks.

For optional 1-1/2" lip length, specify 5101-112 or 5102-112.

5201—1-5/8" × 2-1/4" full curved lip strike with square corners. 1-1/8" lip length. Optional for all T900 Series locks.

5202—1-5/8" × 2-1/4" full curved lip strike with 1/4" radiused corners. 1-1/8" lip length. Optional for all T900 Series locks.

5001—ANSI 1-1/4" × 4-7/8" strike. 1-3/16" lip length. Optional for all T900 Series locks. Includes dust box.

For optional 7/8" and 1-1/2" lip lengths, specify 5001-078 or 5001-112.



www.dorma.com



DORMA USA, Inc.
Dorma Drive, Drawer AC
Reamstown, PA 17567
Tel: 800 523 8483
Fax: 800 274 9724
archdw@dorma-usa.com

DORMA Canada
1680 Courtney Park Drive, Unit 13
Mississauga, Ontario L5T 1R4
Tel: 800 387 4938
Fax: 905 670 5850
sales@dormacanada.com

DORMA Mexico
Calle Sur 110 no. 63, Col. Tolteca
01150 México, D.F.
Tel: 5255 5272 6937
Fax: 5255 5272 6948
operacion@dorma.com.mx