

TECHNOLOGY IN MOTION



MACO MULTI-MATIC

SECURITY TECHNOLOGY



Freedom Without Compromise

BURGLARY RESISTANCE
TIMBER AND
PVC WINDOWS
MULTI-MATIC



„Opportunity makes a thief“

... as the old saying goes and these are precisely the thieves and offenders who spontaneously pick their targets during the day between 12 o'clock noon and 8 PM, where they expect no hindrances.



MACO fittings can stand up to this!



The Opportunist Thief - The (Un)Known Being?!



WHERE do burglars break in?

According to statistics, burglars main routes are through windows in **over 80 %** of cases or through patio doors, and not through main door or apartment entrance doors as is often wrongly assumed.

LEGENDE

- **Patio door 41 %**
- Window, ground floor 28.7 %
- Main door 12.4 %
- Balcony doors 1st floor 6.5 %
- Basement window 4.9 %
- Basement door 3.2 %
- Ancillary entrance doors 2.2 %
- Window, 1st floor 1.1 %

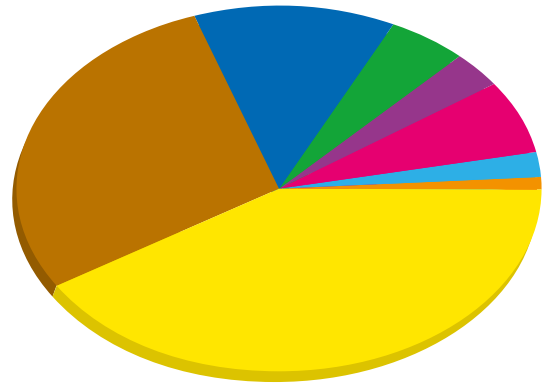

HOW do thieves break in?

Burglars with simple tools can open a window relatively quickly.

Almost 70 % of burglaries through windows are carried out with a screwdriver with 6 to 12 mm blade width.

LEGENDE

- **Lever out the rebate 73.68 %**
- Levered out on the hinge side 3.80 %
- When tilted 13.51 %
- Open/unlocked 1.55 %
- Smash glass/climb through 0.62 %
- Smash glass, reach through and unlock 4.81 %
- Press open with brute force 1.16 %
- Drill through the frame, manipulate the handle and unlock 0.62 %

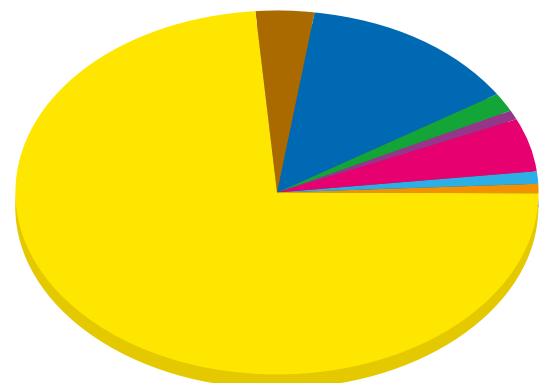



i.S. = intelligent security



- No adjustments needed. Adapts automatically to the air gap (± 2 mm).

- Smooth-running due to highly rigid material and a slide coating.

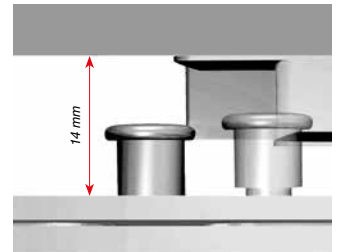

- Can be combined with standard striker or security striker.

- i.S. satisfies all the requirements of EN 1627 - 1630 (RC 1 N - RC 4) and DIN 18104-2

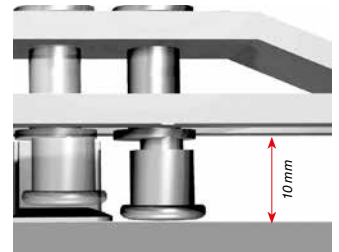

Standard locking cam

Jemmy without any difficulty.

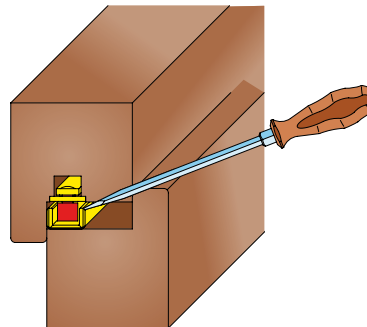

i.S. security roller cams

Window fittings with security cam and burglar-resistant strikers make jemmying much more difficult.

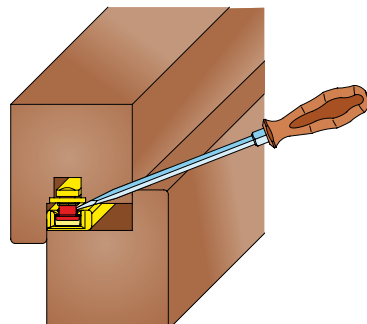



Burglar-resistant strikers

- Special material compound and sophisticated die casting process makes them absolutely stable.
- i.S. security cams are screwed into the frame

reinforcement on the PVC window.

- The following screws are used for strikers in timber windows: 2x straight and 1x diagonal.



Compression

- The contact pressure is adjusted by rotating the eccentrically mounted i.S. security cam.



Gasket-compression easy to adjust using TX 15

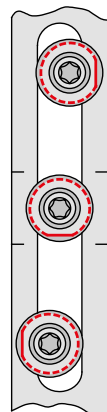

Less gasket-compression

Sash overlap side

Original position with the flat surface faced towards the eccentric cam.

More gasket-compression

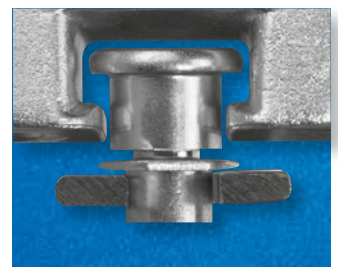



How to handle security properly



- Interlockable and lockable window handles enhance the safety of each window.
- MACO window handles are available in three different designs and in a wide range of colours.



Window handle locking button or locking cylinder

Handles are safeguarded against ...

	Standard handle	Locking button	Locking cylinder
Open sash	X	X	X
Slide fitting	X	✓	✓
Turn with window tilted (rope trick)	X	✓	✓
Smash glass and turn handle manually	X	X	✓
Drill through the frame to spindle	X	✓	✓
Drill through the frame and use aid to turn handle	X	✓	✓
Additional comfort			
Always locked automatically	X	✓	X

- Opening the sash is not prevented.
- Comfort through multiple utilisation, e.g. when used in children's rooms.



Extra protection against unwanted intrusion!



MACO "TRESOR" window handles

- 100 Nm resistance to breaking off the window handle from the sash.
- **100 Nm resistance** to breaking off the locking mechanism at the window handle.

MACO-TRESOR window handles offer a higher degree of security than required by EN V 1627 - 1630.

A test certificate is available from us on request.



TRESOR S with locking button

For all resistance classes with burglar-resistant glazing.

- The window is always operable.
- The handle and/or window are always locked.
- No key is required
- Increased safety for small children.



TRESOR-Z with locking cylinder

For RC 1 N / RC 2 N for standard glazing and all higher classes.

- No unauthorized operation possible (e.g.: in public buildings, such as schools, hospitals, etc.).
- High security for children.
- Windows and glazed doors still cannot be opened using the window handle, even when the window pane has been cut out. Satisfies the requirements of DIN 18104-2.



MACO provides security...



MACO basic security – non-tested

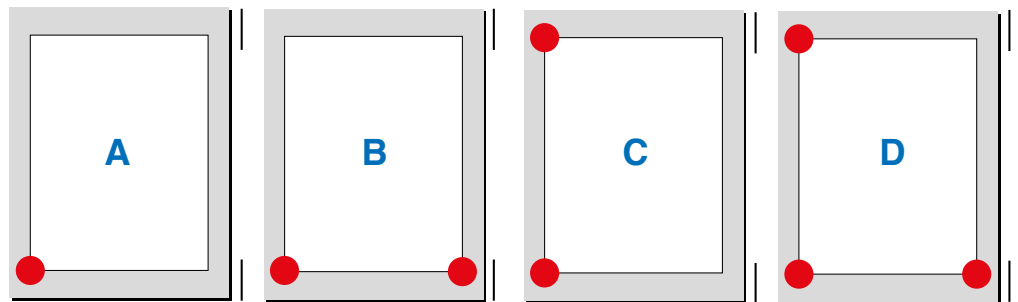

- This type of protection is conceived for the inexperienced occasional thief and vandal.
- Individual corners (points) are secured. No special requirements are placed on the window design and components.
- Many windows already include one or two burglar-resistant points as standard (e.g. bottom horizontal tilt closer).



Security that you can pass on to your customers



EN-V - standardised security

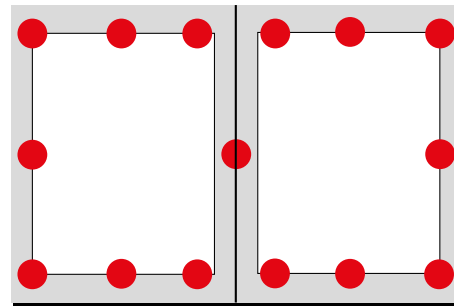
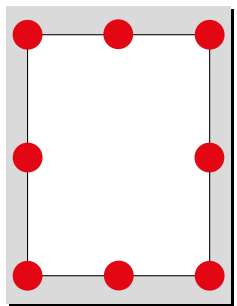

- Depending on the particular resistance class (RC), windows fabricated according to **EN**, offer enhanced protection to thwart opportunistic/experienced thieves.
- **EN 1627 - 1630** classifies six resistance classes (RC). This makes sense for windows and French windows up to RC 3 and is feasible in these cases.
- Upwards of RC 4, only special designs are possible.
- **EN-V 1627 - 1630** applies in many countries (e.g. Germany, Switzerland, Holland, Belgium and Austria) as the national standard.
- Test certificates are not only intended for the applicant (fittings manufacturer) but can also be passed on (in the form of licenses). Test reports acc. to DIN V ENV 1627 RC 2 are still valid.

RC stands for Resistance Class.





Additional product service



Safety workshops

- Including training certificate and detailed documents.



Security workshop - system tests

- Workshop for burglar-resistant windows acc. to EN 1627 - 1630.
- For installation in timber/aluminium windows.
- For installation in PVC windows.
- Numerous profile systems.
- For installation in timber with timber/aluminium windows.
- Passive house system, country-specific systems



In-house tests

- In our test centres, windows are tested to the most stringent criteria.
- MACO's security system satisfies all the requirements of EN-V 1627 - 1630.



**MACO
MULTI-MATIC**



MACO basic security

Non-tested security





MACO basic security Non-tested security

Levels:



Application:

Basic living area

Resistance :

against vandalism

Assessment:

low protection, since only secured at certain points

Testing procedure:

none

Design features:

standard window designs

Glazing:

no requirement

Window handle:
cylinder

lockable window handles with locking button or locking

Installation in the wall:

standard installation

Retro-fit:

possible at any time

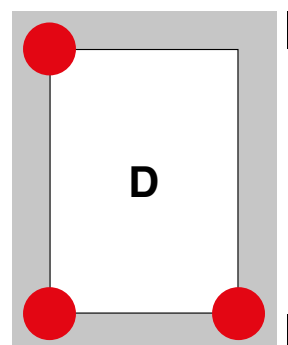
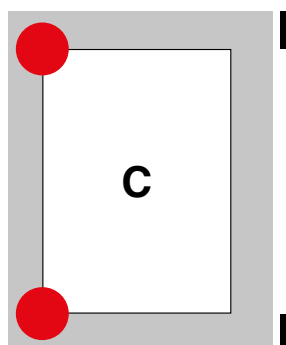
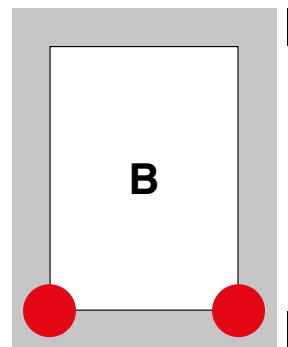
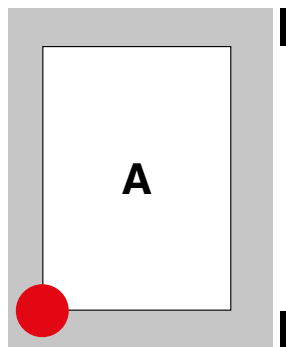

All safety-relevant components are marked red!
Combinations of fittings on this page are suggestions from MACO!

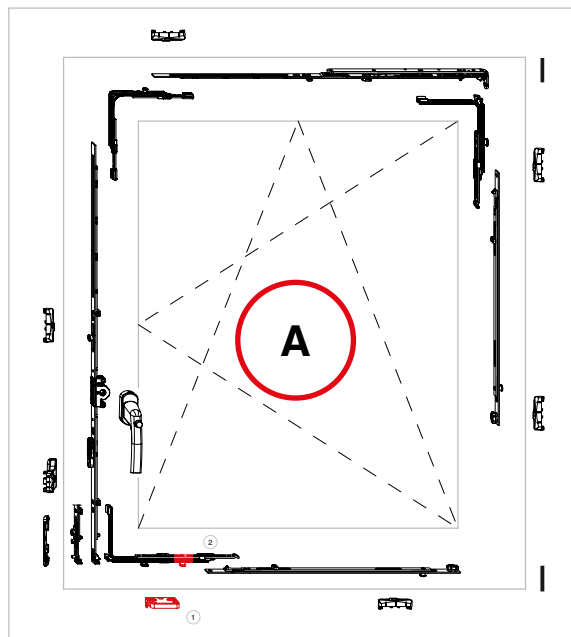

Standard solution

- ① 1 security striker
- ② 1 extendible corner element with 1 i.S.

Basic security

A

All safety-relevant components are marked red!
Combinations of fittings on this page are suggestions from MACO!

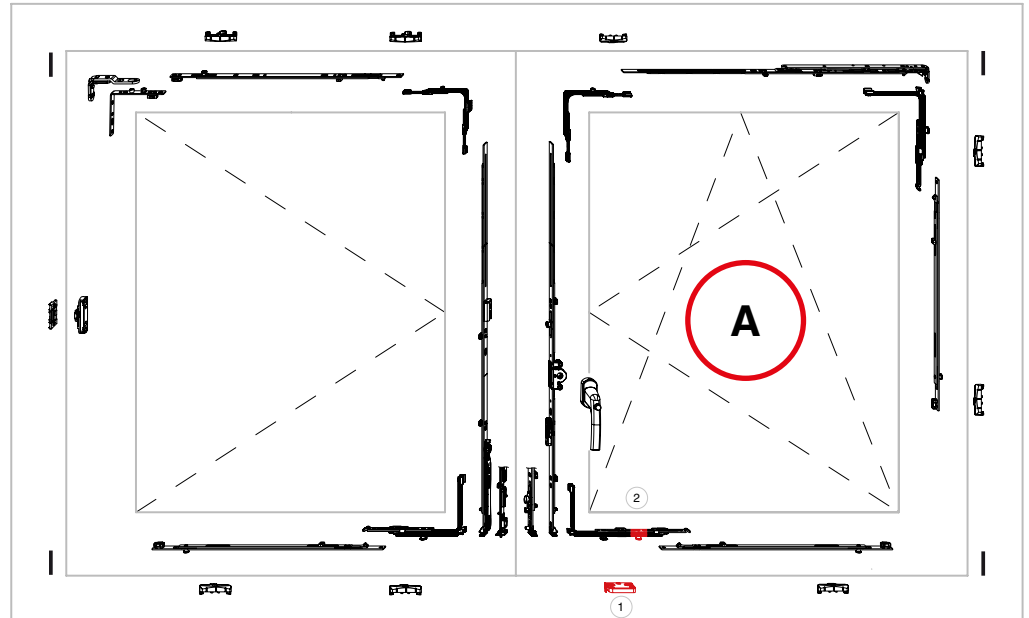

1 1 security striker

2 1 extendible corner element with 1 i.S.

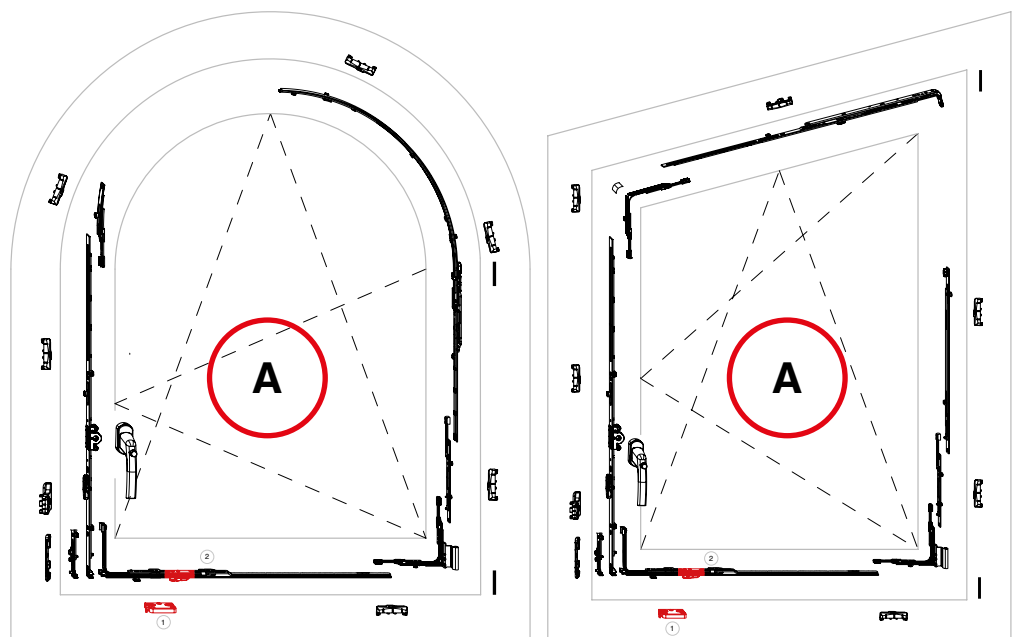

1 1 security striker

2 1 horizontal extendible corner element
for arched windows with 1 i.S.

Basic security

B

All safety-relevant components are marked red!
Combinations of fittings on this page are suggestions from MACO!

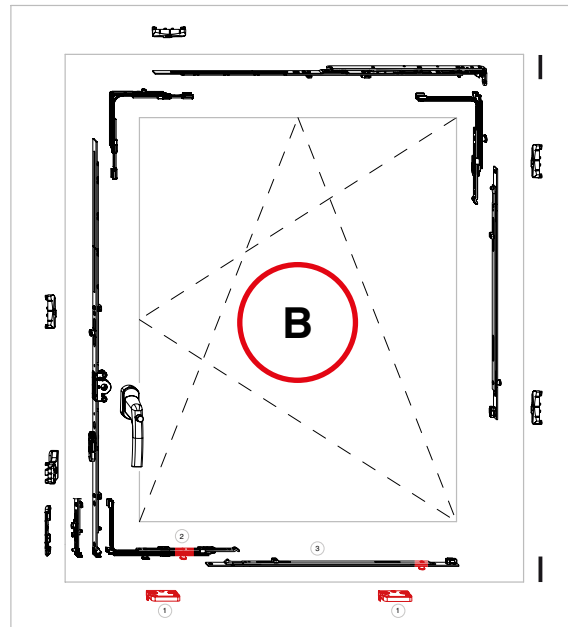

- 1 2 security strikers
- 2 1 extendible corner element with 1 i.S.
- 3 1 centre lock 1280 with 1 i.S.

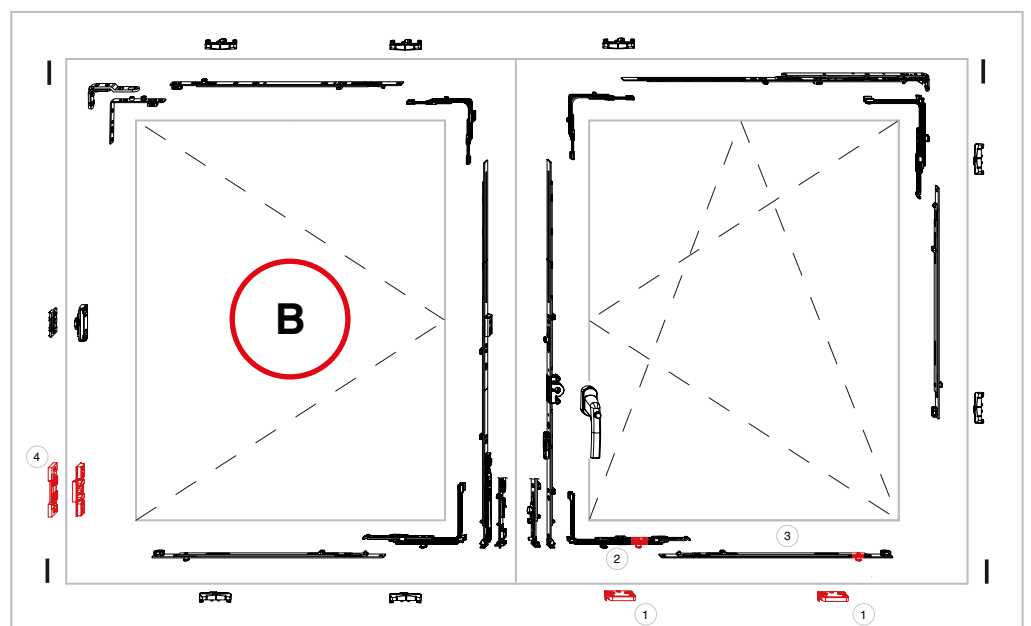

Basic security

B

All safety-relevant components are marked red!
Combinations of fittings on this page are suggestions from MACO!

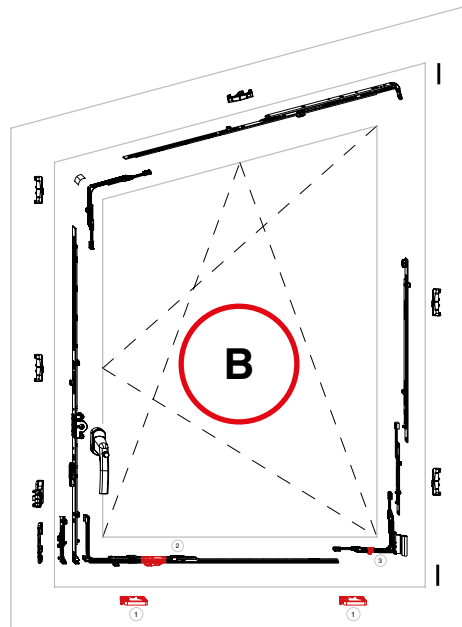

- 1 2 security strikers
- 2 1 horizontal extendible corner element for arched windows with 1 i.S.

- 3 1 corner support i.S.

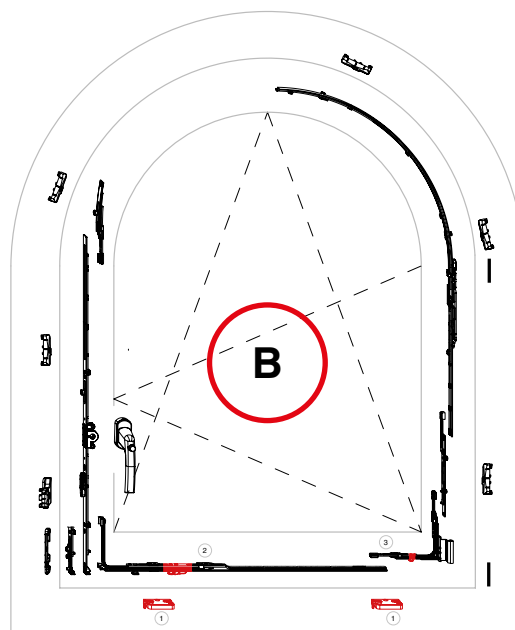

- 1 2 security strikers
- 2 1 horizontal extendible corner element for pitched windows with 1 i.S.

- 3 1 corner support i.S.

All safety-relevant components are marked red!
 Combinations of fittings on this page are suggestions from MACO!

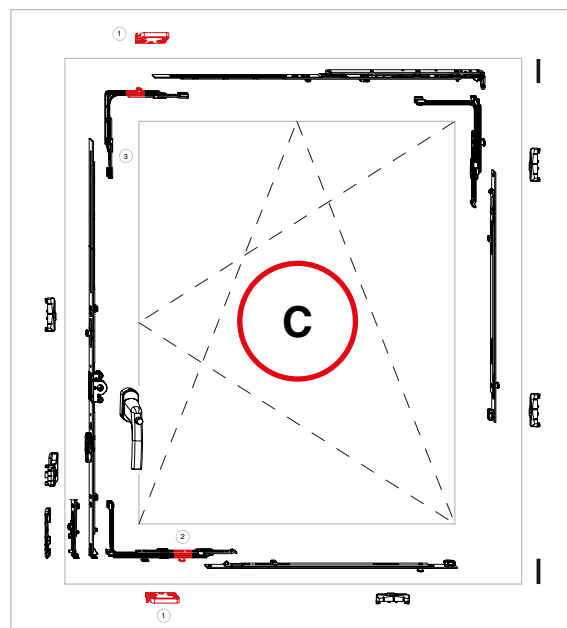

Standard solution

- ① 2 security strikers
- ② 1 horizontal extendible corner element with 1 i.S.
- ③ 1 corner element with 1 i.S.

Basic security

C

All safety-relevant components are marked red!
Combinations of fittings on this page are suggestions from MACO!

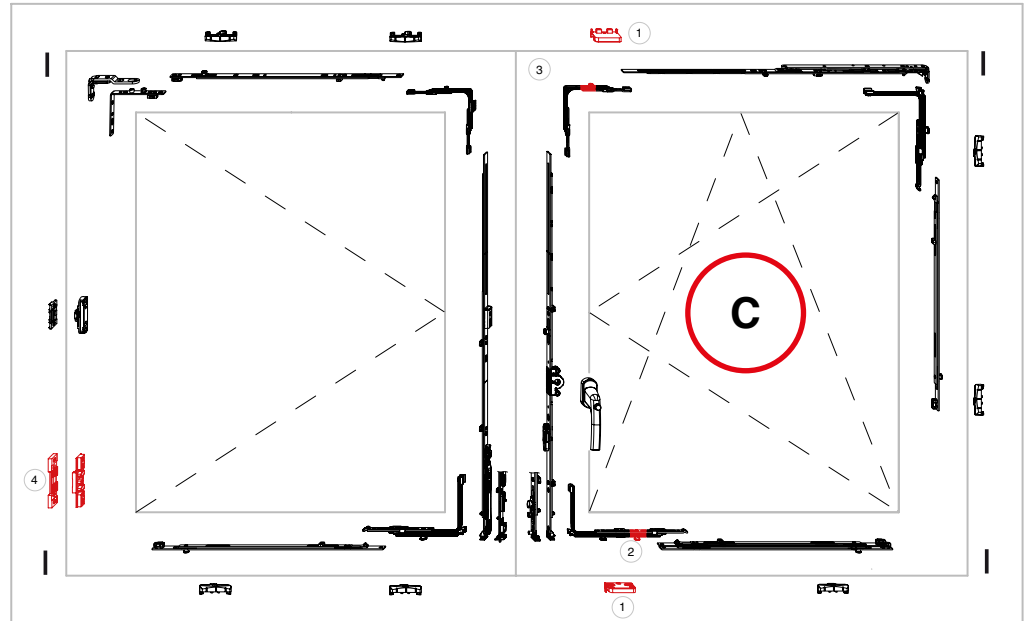

- 1 2 security strikers
- 2 1 horizontal extendible corner element with 1 i.S.
- 3 1 corner element with 1 i.S.
- 4 1 turn-only hinge safety device

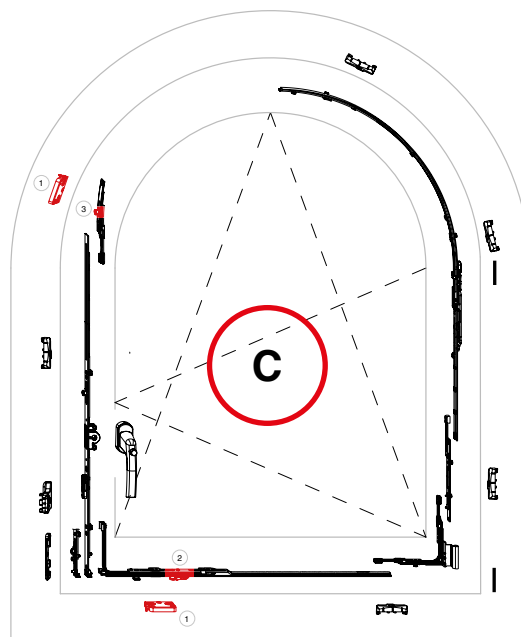

- 1 2 security strikers
- 2 1 horizontal extendible corner element for arched windows with 1 i.S.
- 3 1 Top end piece for arched windows 1 i.S.

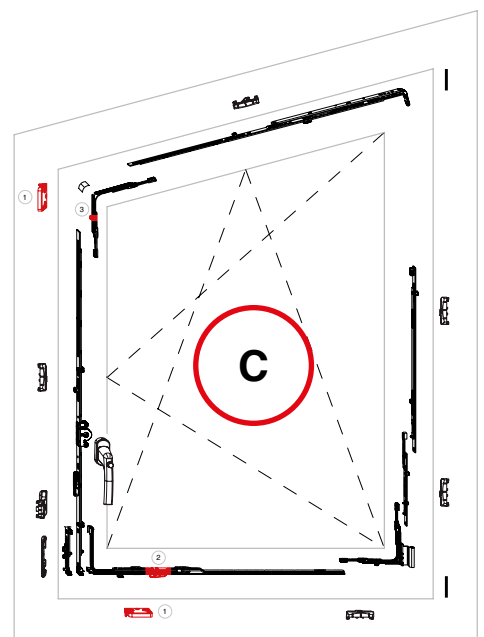

- 1 2 security strikers
- 2 1 horizontal extendible corner element for pitched windows with 1 i.S.
- 3 1 corner element for pitched windows with 1 i.S.

Basic security

D

All safety-relevant components are marked red!
 Combinations of fittings on this page are suggestions from MACO!

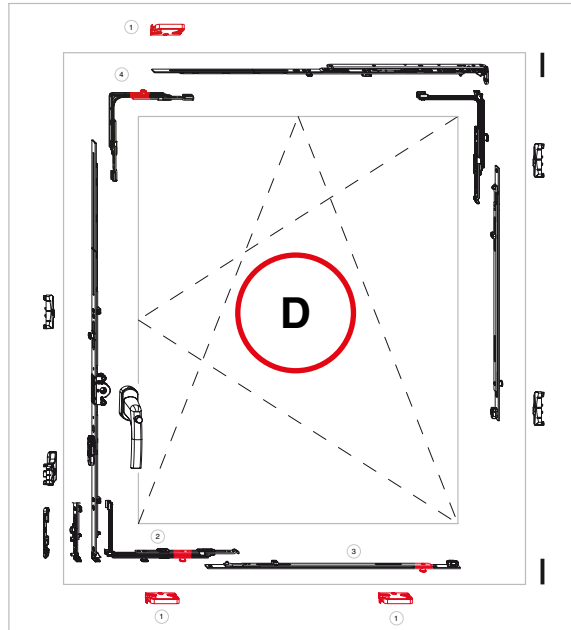

- 1 3 security strikers
- 2 1 horizontal extendible corner element with 1 i.S.
- 3 1 centre lock 1280 with 1 i.S.
- 4 1 corner element with 1 i.S.

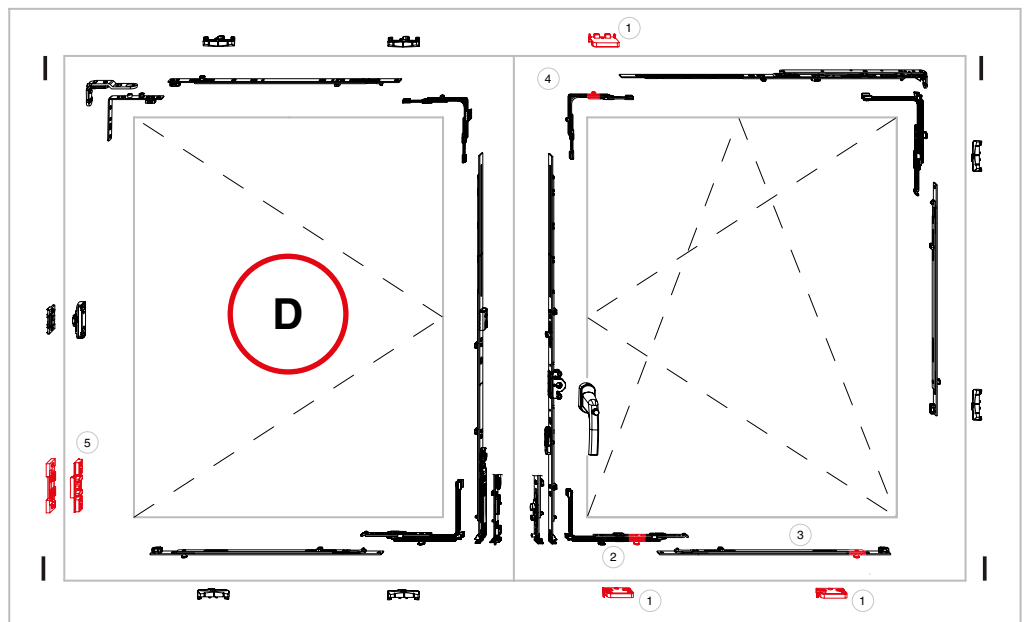

- 1 3 security strikers
- 2 1 horizontal extendible corner element with 1 i.S.
- 3 1 centre lock 1280 with 1 i.S.
- 4 1 corner element with 1 i.S.
- 5 1 turn-only hinge safety device



Basic security **D**

All safety-relevant components are marked red!
Combinations of fittings on this page are suggestions from MACO!

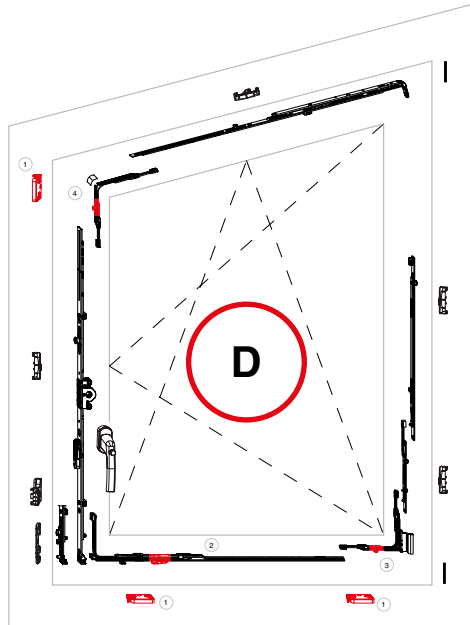

- 1** 3 security strikers
- 2** 1 horizontal extendible corner element for arched windows with 1 i.S.
- 3** 1 corner support i.S.
- 4** 1 Top end piece for arched windows 1 i.S.

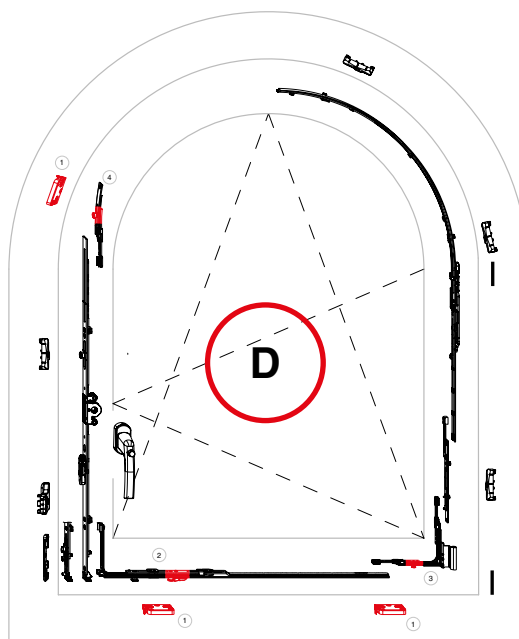

- 1** 3 security strikers
- 2** 1 horizontal extendible corner element for pitched windows with 1 i.S.
- 3** 1 corner support i.S.
- 4** 1 corner element for pitched windows with 1 i.S.

**MACO
MULTI-MATIC**



EN 1627 - 1630

European standardised security



Standardised security

National standard for:

Germany	DIN EN 1627 - 1630
Austria	ÖNORM EN 1627 - 1630, ÖNORM B 5338
Switzerland	SN EN 1627 - 1630



EN 1627 - 1630 European standardised security

Revision of the predecessor standard EN V 1627 : 1999 has resulted in the following modifications in the current version and possible implications.

The background to the revision of the series of standards was an alignment with the state-of-the-art in the technology and an improved reproducibility of the tests.

What is new is the new designation "RC" for resistance class to replace the German abbreviation "WK".

Nothing has changed for the 6 resistance classes.

resistance class EN 1627 : 2011	Resistance class EN V 1627 : 1999
RC 1 N	-
RC 2 N	-
RC 2	WK 2
RC 3	WK 3
RC 4	WK 4
RC 5	WK 5
RC 6	WK 6

The table above shows that RC 2 has been divided into two different resistance classes. The supplement "N" for resistance classes RC 1 N and RC 2 N stands for normal and means that normal glass without burglary-resistant characteristics can be used here. This classifies a standardized class 2 with no requirements for the glazing.

Test reports acc. to DIN V ENV 1627 are still valid; this is governed by the last sentence in Section 4 of the current successor standard DIN EN 1627:2011-09:

With respect to the use of historical test results, it can be assumed that products classified acc. to ENV 1627:1999 in classes 2 to 6 correspond to the same classes of this standard.

Depending on the particular resistance class, windows fabricated according to EN offer enhanced protection to thwart opportunist/experienced thieves who use simple to special levering tools.

-*+Tests in accordance with these standards are individual tests carried out on the finished window and must be applied for by the window manufacturer, and performed in an approved testing institute. On a national level, it is also possible, under certain conditions (under instruction) to use the test certificates from system manufacturers (fitting, profile). The standard is divided into six classes RC 1 to RC 6 with differing requirements on the element. Window tests make sense in classes RC 1 to RC 3. Applications: high-risk living areas and business areas.

Your technical consultant will be pleased to help you with the experience gained from these tests and give you advice on the essentials of window manufacture. If required, preliminary tests can be carried out in-house at Maco's Salzburg location.

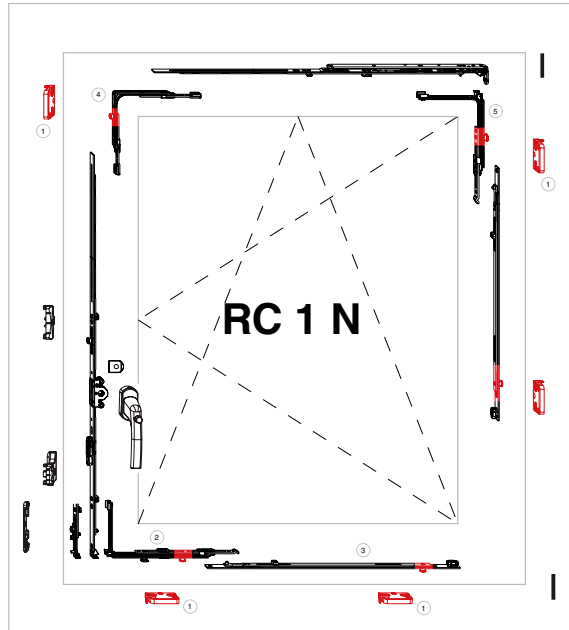

- 1 4 security strikers
- 2 1 horizontal extendible corner element with 1 i.S.
- 3 2 centre locks 1280 with 1 i.S.
- 4 1 corner element with 1 i.S.
- 5 1 vertical extendible corner element with 1 i.S.

The number of locking points depends on the window size!

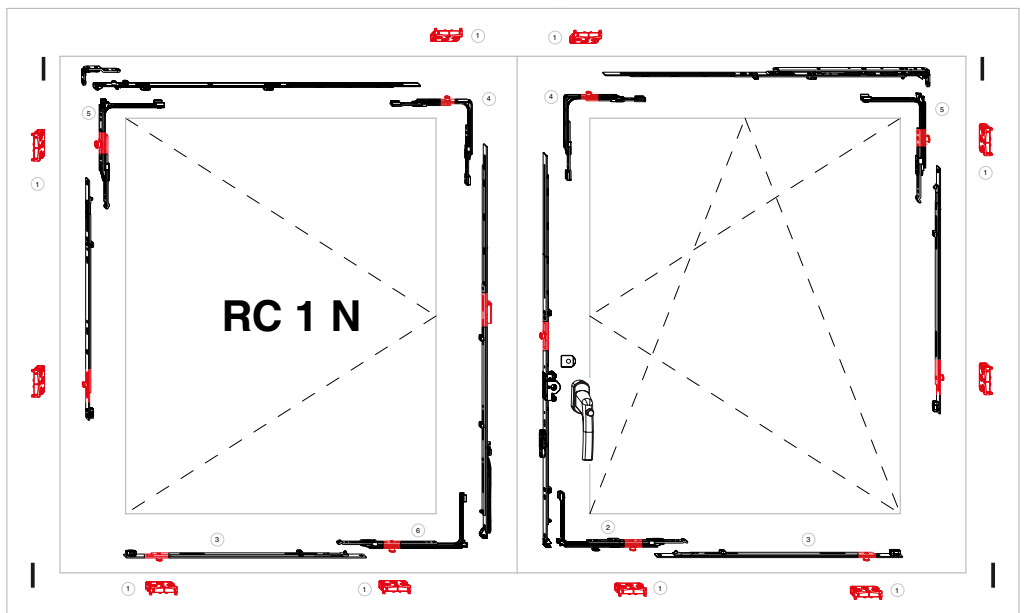

- 1 4 security strikers
- 2 1 horizontal extendible corner element with 1 i.S.
- 3 2 centre lock 1280 with 1 i.S.

- 4 1 corner element with 1 i.S.
- 5 1 vertical extendible corner element with 1 i.S.
- 6 1 vertical extendible corner element with 1 i.S.



Resistance class RC 1 N

Application:	Living areas such as ground floors and easily accessible balconies.
Type of offender:	Opportunistic intruder.
Resistance:	Against brute force, without using tools.
Assessment:	Good protection; each corner is protected (suggestion profile-dependent)
Testing procedure:	Static testing (pressure cylinder) with additional belt loading against the locking direction. Dynamic testing with dual tyre (50 kg impactor) and a 3-minute preparation time with toolset A1 (all parts on the attack side may be unscrewed, removed or dismantled). A P4A glazing acc. to EN 356 must be used for the test.
Processing:	Observe precise air gap and welding temperature for rigidity of corner joints. Glue the timber corner joints well.
Glazing:	Standard glazing
Window handle:	Lockable „TRESOR“ window handles with locking cylinder or locking cylinder. Caution: Locking button only for burglar-resistant glazing.
Drill protection:	Minimum surface hardness 60 HRC, hardness depth 0.5 mm
Fittings:	Refer to fittings matrix.
Installation in the wall:	Detailed installation instructions with information about surrounding walls, screws and cladding is included in each test certificate and must be observed.

Resistance class RC 2 / RC 2 N

Application:	Living area with high risk of burglary and business areas.
Type of offender:	Experienced intruder who uses tools.
Resistance:	Against simple levering tools such as screwdrivers and wedges.
Assessment:	Good protection since all intrusion points are protected.
Testing procedure:	Static testing (pressure cylinder) and dynamic testing with dual tyre (impactor 50 kg). Manual testing (toolset A2) with pretesting (weak point analysis) and main test lasting 3 min. For RC 2 and RC 2 N testing, a P4A glazing acc. to EN 356 must be used.
Design features:	Standard window and window designs
Processing:	Observe precise air gap and welding temperature for rigidity of corner joints. Glue the timber corner joints well.
Glazing:	For RC 2, a P4A glazing must be used. For RC 2 N, standard glazing can be used (country-specific regulations).
Window handle:	Lockable „TRESOR“ window handles with locking cylinder or locking button with 100 Nm resistance (pulling off, breaking off).
Drill protection:	Minimum surface hardness 60 HRC, hardness depth 0.5 mm
Fittings:	Refer to fittings matrix.
Installation in the wall:	Detailed installation instructions with information about surrounding walls, screws and cladding is included in each test certificate and must be observed.



RC 2 / EN 1627 - 1630 — Profile section for PVC windows

Scissor stay faceplate

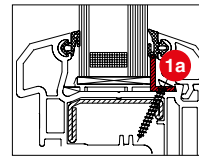
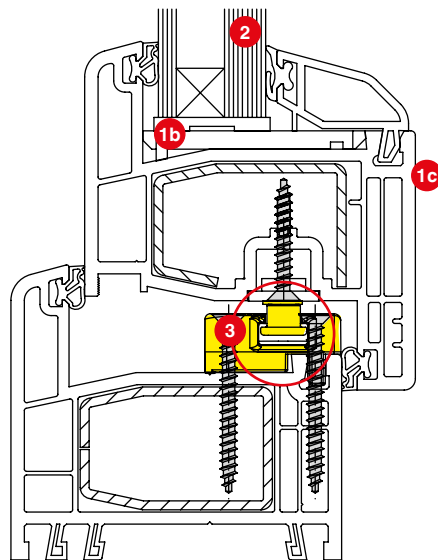
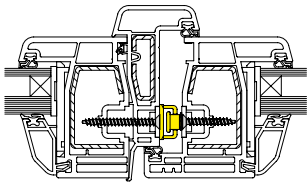

- 1 Observe precise air gap of 12 mm.
- 1a For fixed glazing with aluminium angle screwed the reinforcement.
- 1b Glue the glass to the sash (silicone adhesive, e.g.: Rota Bond, Ramsauer 640, Soudal Fix All) or 2K adhesive e.g.: Otto Chemie OTTOCOOL S81. Important: When gluing in the pane, check that the adhesive and the edge joint are compatible.
- 1c Glass strip and sash profile are cold-welded
- 2 P4A (A3) glass.
- 3 Fittings are fastened into the reinforcement, and into the PVC for the sash.

RC 2 / EN 1627 - 1630 — Profile section for timber windows

All timber types that are typical for window-making can be used to manufacture the window units. The raw density is specified in VFF leaflet HO.06 from ift Rosenheim.

Faceplate

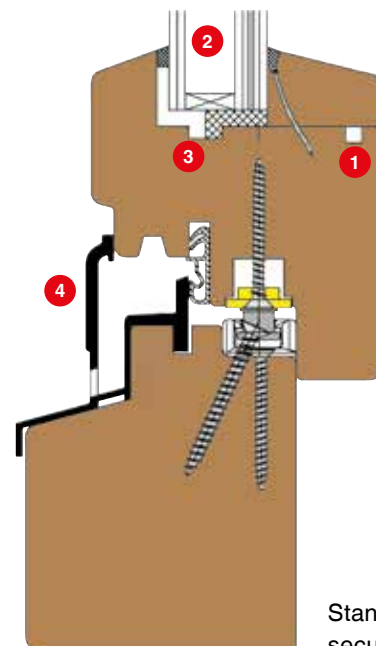

Standard design of security strikers

- 1 Observe precise air gap of 12 mm.
- 1 Concealed, pinned glass retaining strip (Senco pins)
- 2 A3 / P4A glass
- 3 Glue the glass to the sash (silicone adhesive, e.g.: Rota Bond, Ramsauer 640, Soudal Fix All) or 2K adhesive e.g.: Otto Chemie OTTOCOOL S81. Important: When gluing in the pane, check that the adhesive and the edge joint are compatible.
- 4 Standard drip rail (installation as before)

Standardised security EN 1627 - 1630

All safety-relevant components are marked red!

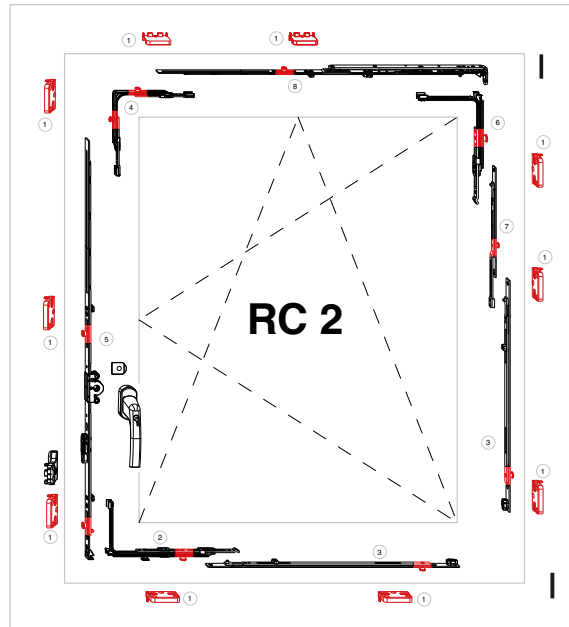

- 1 10 security strikers
- 2 1 horizontal extendible corner element with 1 i.S.
- 3 1 centre lock 1280 with 1 i.S.
- 4 1 corner element with 2 i.S.
- 5 1 T&T drive gear BR fixed i.S.
- 6 1 vertical extendible corner element with 1 i.S.
- 7 1 extendible faceplate 235 with 1 i.S.
- 8 1 scissor stay i.S.

Standardised security

The number of locking points depends on the window size!

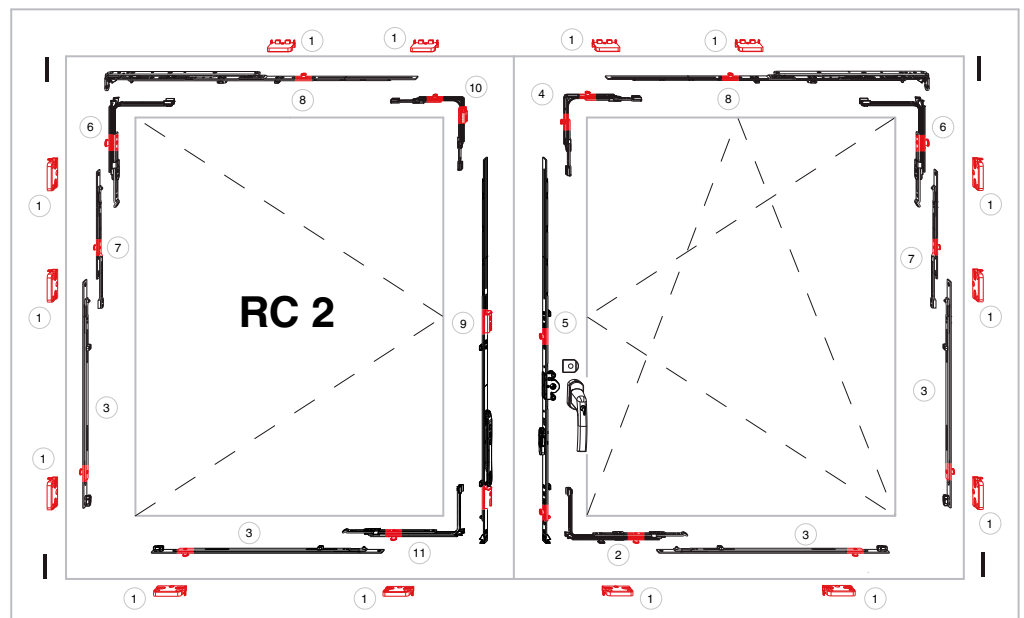

- 1 14 security strikers
- 2 1 horizontal extendible corner element with 1 i.S.
- 3 4 centre lock 1280 with 1 i.S.
- 4 1 corner element with 2 i.S.
- 5 1 drive gear BR fixed i.S.
- 6 2 vertical extendible corner elements with 1 i.S.
- 7 2 extendible faceplate extensions 235 with 1 i.S.
- 8 2 i.S. scissor stays
- 9 1 French casement drive gear BR fixed
- 10 1 corner element for French casement drive gear with slider lock with 1 i.S.
- 11 1 horizontal extendible corner element with i.S.



Resistance class RC 3

Application:	Business area with increased risk of burglary (jewellers, banks, etc.).
Type of offender:	Experienced intruder who uses special tools.
Resistance:	Against special tools, crowbar, screwdriver, wedges.
Assessment:	Extremely good protection, all components are additionally reinforced.
Testing procedure:	Static testing (pressure cylinder) and dynamic testing with dual tyre (impactor 50 kg). Manual testing (Toolsets A2 & A3) with pretesting weak point analysis) and main test lasting 5 min.
Design features:	Standard windows and French doors with inserts in the outer hollow sections of the sash and frame profile.
Processing:	Observe precise air gap and welding temperature for rigidity of corner joints. Glue the timber corner joints well.
Glazing:	acc. to EN 356 P5A.
Window handle:	Lockable“ TRESOR “ window handles with locking cylinder or locking button with 100 Nm.
Drill protection:	Minimum surface hardness 60 HRC, hardness depth 0.5 mm
Fittings:	see fitting matrix
Installation in the wall:	Detailed installation instructions with information about surrounding walls, screws and cladding is included in each test certificate and must be observed.



RC 3 / EN 1627 - 1630 — Profile section for PVC windows

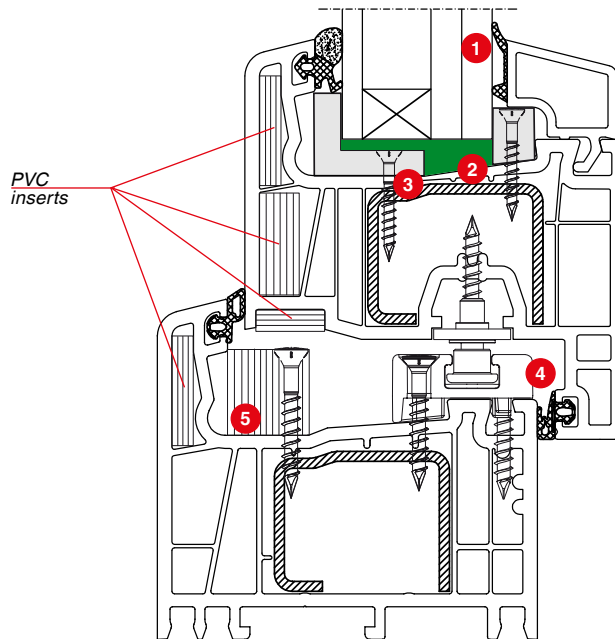

- ❗ Observe precise air gap of 12 mm
- ❶ P5A (B1) glass
- ❷ Glue glass and sash (MS polymer adhesive, e.g.: Rota Bond, Soudal Fix All, Ramsauer 670/690) or 2K adhesive Important: Otto Chemie OTTOCOOL S81. Important! When gluing in the pane, check that the adhesive and the edge joint are compatible
- ❸ Aluminium profile fastened
- ❹ Fasten the fittings to the frame and sash reinforcement
- ❺ PVC profile fastened as air gap restrictor

Standardised security

RC 3 / EN 1627 - 1630 — Profile section for timber windows

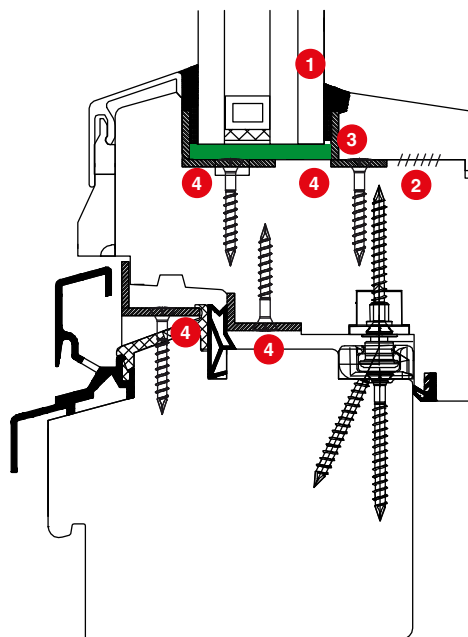

- Hardwood upwards of 600 kg/m³ is possible; profile width should be at least IV-78. Furthermore, RC 3 is only possible with a considerable number of i.S. security strikers as a non-height-adjustable version. Reinforcements are required.
- ❗ Observe precise air gap of 12 mm
 - ❶ P5A (B1) glass
 - ❷ Glass retaining strip glued
 - ❸ Glue glass with sash (MS polymere adhesive e.g.: Rota Bond, Ramsauer 670/690, Soudal Fix All) or 2K adhesive e.g.: Otto Chemie OTTOCOOL S81. Important! When gluing in the pane, check that the adhesive and the edge joint are compatible
 - ❹ Aluminium profile fastened

Standardised security PN - EN 1627 - 1630

Alle sicherheitsrelevanten Teile sind rot gekennzeichnet!

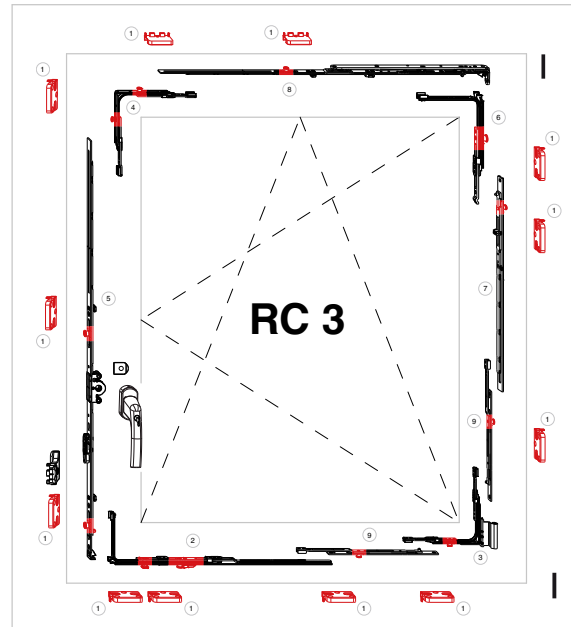

- | | | | |
|---|---|---|---|
| 1 | 12 security strikers | 6 | 1 extendible vertical corner element with 1 i.S. |
| 2 | 1 horizontal extendible corner element for arched windows with 1 i.S. | 7 | 1 faceplate extension for B-TV with 1 i.S. |
| 3 | 1 corner support i.S. | 8 | 1 scissor stay i.S. |
| 4 | 1 corner element with 2 i.S. | 9 | 2 extendible faceplate extensions 235 with 1 i.S. |
| 5 | 1 T&T drive gear BR fixed i.S. | | |





The number of locking points depends on the window size!

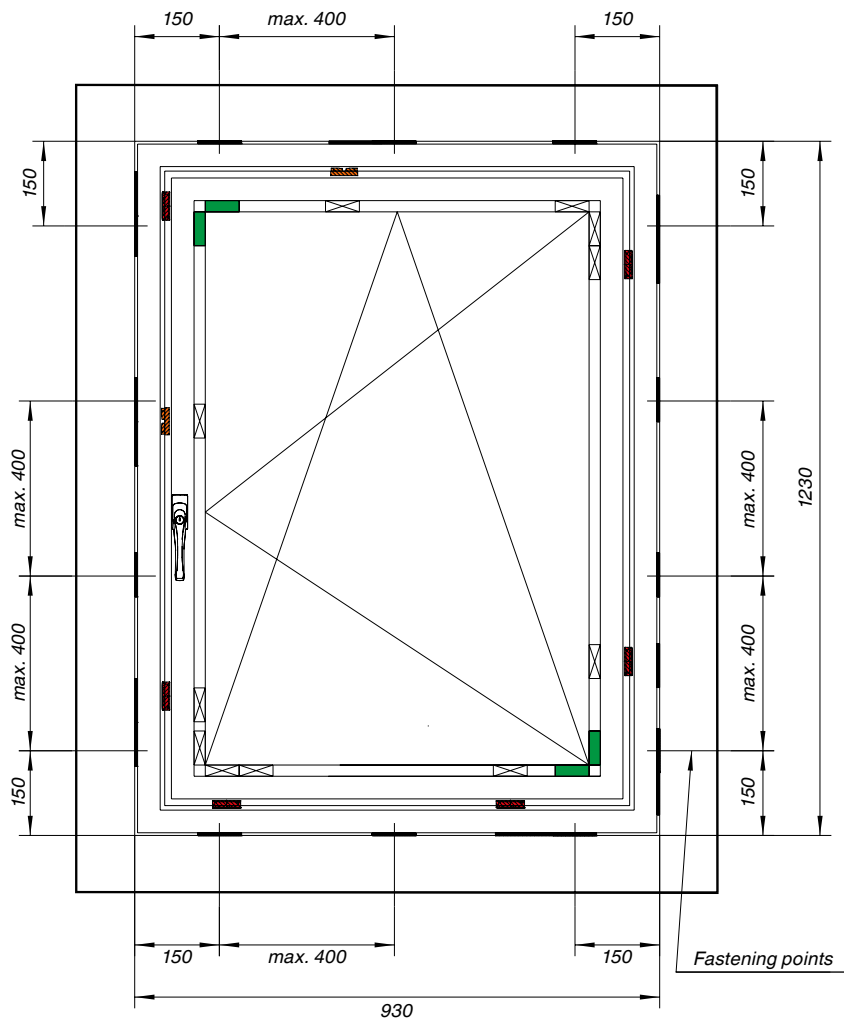

Centring and Cladding For RC 1 to RC 3 Spacer blocks and pressure-resistance underlays . . .

. . . in the area of i.S. locking points ensure that the forces exerted can be dissipated in the event of burglary.



-  Pressure-resistant cladding
-  Spacer block
-  Centring
-  i.S. striker
-  Standard striker



DIN 18104, Part 2 addresses additional products that can be installed later in the rebate of door and window elements. Retrofitting of burglar-resistant tilt&turn fitting systems must be assigned to this Part 2 of Standard 18104.

DIN 18104-2

"Additional products embedded in the rebate for windows an French doors."

The visual appearance and user-friendliness of the retrofitted elements are not adversely affected.

Application: Living area with high risk of burglary and business areas.

Type of offender: Experienced intruder who uses tools.

Resistance: Against simple levering tools such as screwdrivers and wedges.

Assessment: Good protection since all intrusion points are protected.

Testing procedure: **Sliding test for fitting systems:**

- Under 1.5 kN load, the locking system must not shift more than 50 % of the locking path.

Static and manual load on test rig

- The load and measurement of the deflection is carried out according to EN 1628, the test load is 6 kN. The maximum permissible deflection is 10 mm

Resistance to burglar tools

- at least 3 minutes Overall testing time 15 minutes With toolset A2 according to EN 1627

Design features: Standard window and window designs

Processing: as per documentation for tested additional product (DIN 18104-2)

Glazing: According to EN 356 P4A (A3) if possible (recommendation!)

Window handle: lockable "TRESOR" window handles with locking cylinder with 100 Nm resistance (breaking off, pulling off).

Fittings: as per documentation for tested additional product (DIN 18104-2), but at least 7 i.S. cam

Installation in the wall: There are several ways to fasten an additional element a later stage; however a fastening of at least 150 mm must be attached in all 4 corner areas. (recommendation!)



Section variants — Profile section for PVC windows DIN 18104-2

Fittings are fastened to the frame reinforcement

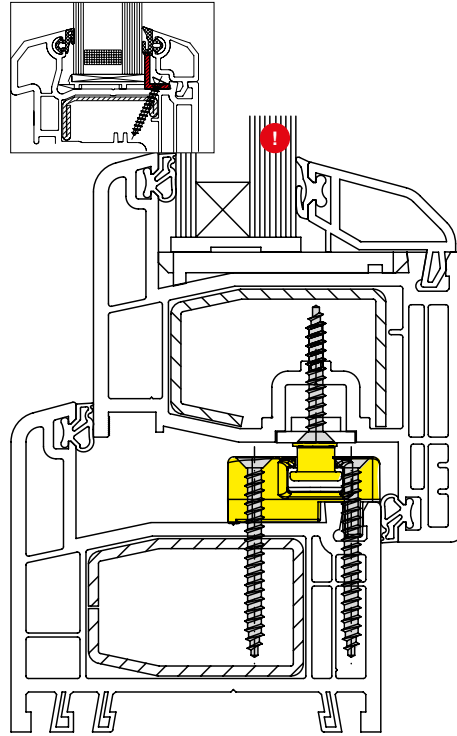

! P4A (A3) Replace the glass if possible (recommendation!)

Further recommendations:

Fastened to reinforcement with aluminium angle.

Glue glass and sash (MS polymer adhesive, e.g.: Rota Bond, Soudal Fix All)

Glass strip and sash profile are cold-welded

Faceplate

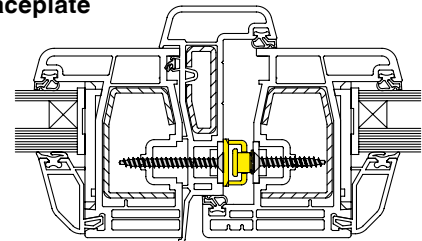

Fittings with long screws fastened to U reinforcement

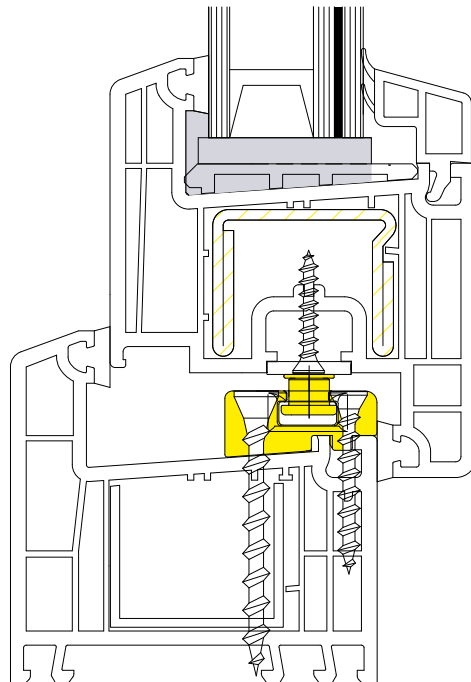

Fittings with strong screws fastened in a drywall plug

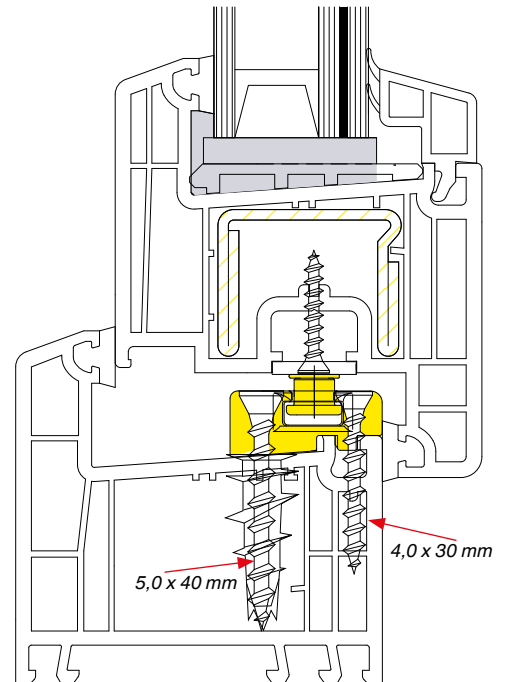



Section variants — Profile section for timber windows DIN 18104-2

System 4 Air

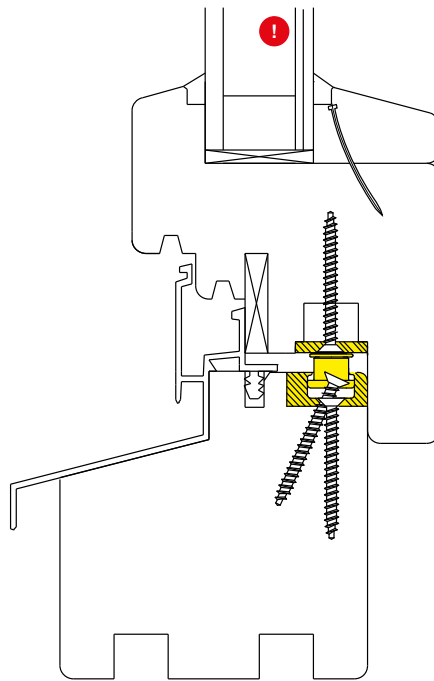

! P4A (A3) Replace the glass if possible (recommendation!)

Further recommendations:

Glue glass and sash
(MS polymer adhesive, e.g.: Rota Bond, Soudal Fix All)

Screws at least 4.0 x 40 mm
(fastening for fitting and strikers)

Pre-drill holes for screws with
Ø 3 mm drill.

Faceplate

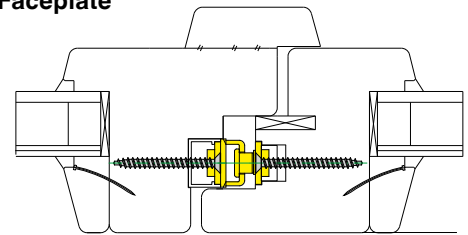

**Euronut system
18 or 20 mm overlap**

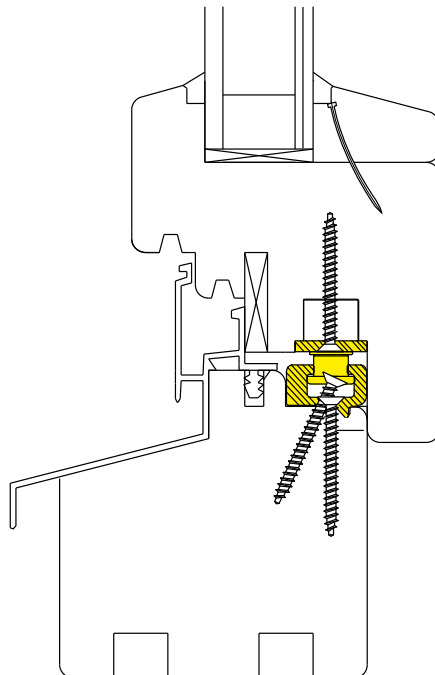

**Eurofalz system
18 or 20 mm overlap**

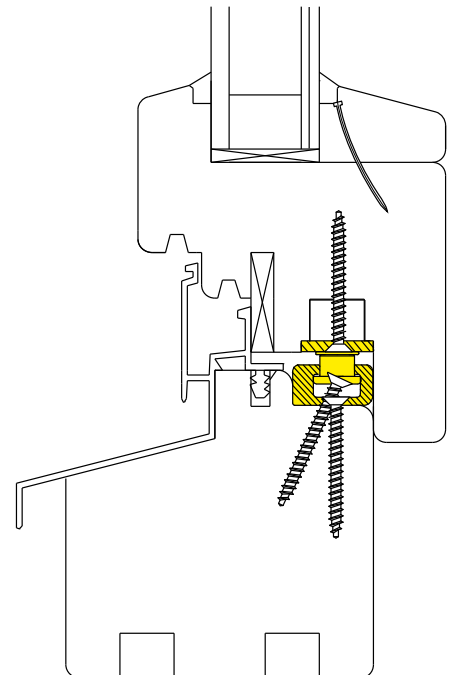

Standardised security

DIN 18104-2

All safety-relevant components are marked red!

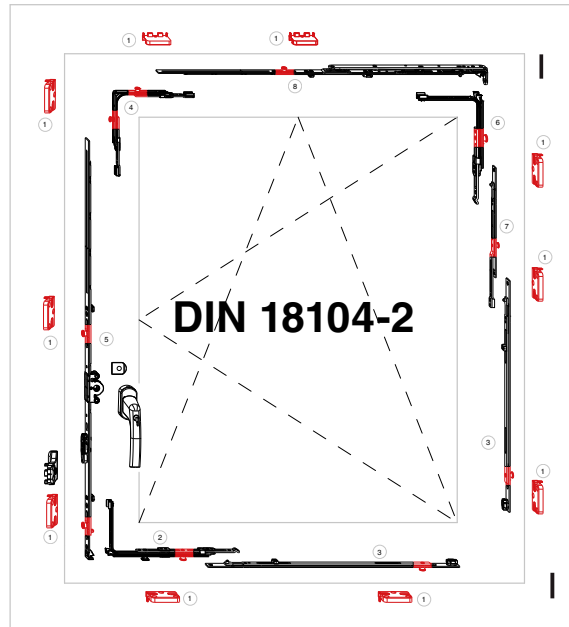

- 1 10 security strikers
- 2 1 horizontal extendible corner element with 1 i.S.
- 3 1 centre lock 1280 with 1 i.S.
- 4 1 corner element with 2 i.S.
- 5 1 T&T drive gear BR fixed i.S.
- 6 1 vertical extendible corner element with 1 i.S.
- 7 1 extendible faceplate 235 with 1 i.S.
- 8 1 scissor stay i.S.

Standardised security

The number of locking points depends on the window size!

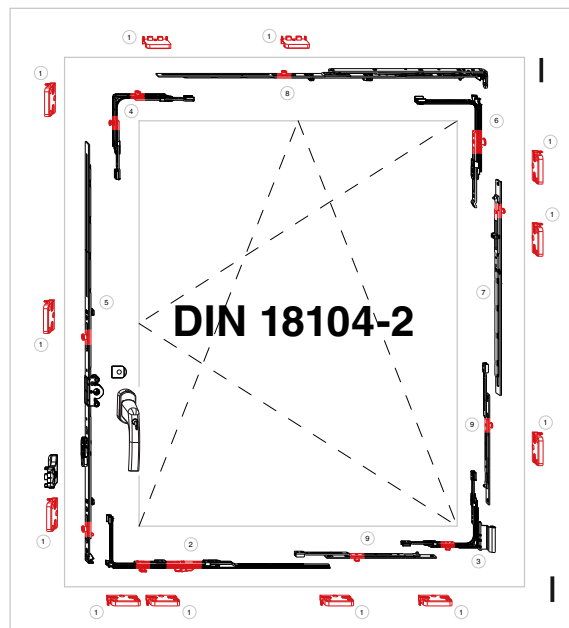

- 1 12 security strikers
- 2 1 horizontal extendible corner element for arched windows with 1 i.S.
- 3 1 corner support i.S.
- 4 1 corner element with 2 i.S.
- 5 1 T&T drive gear BR fixed i.S.
- 6 1 vertical extendible corner element with 1 i.S.
- 7 1 faceplate extension for B-TV with 1 i.S.
- 8 1 scissor stay i.S.
- 9 2 extendible faceplate 235 with 1 i.S.



Notes

A large rectangular area filled with a fine grid pattern, intended for taking notes.



MACO-TRONIC

Electronic locking monitoring and heating control



Your special advantages:

- Electronic window monitoring through connection to central monitoring and alarm system.
- Save energy by connecting to a heating thermostat or to an air-conditioning unit

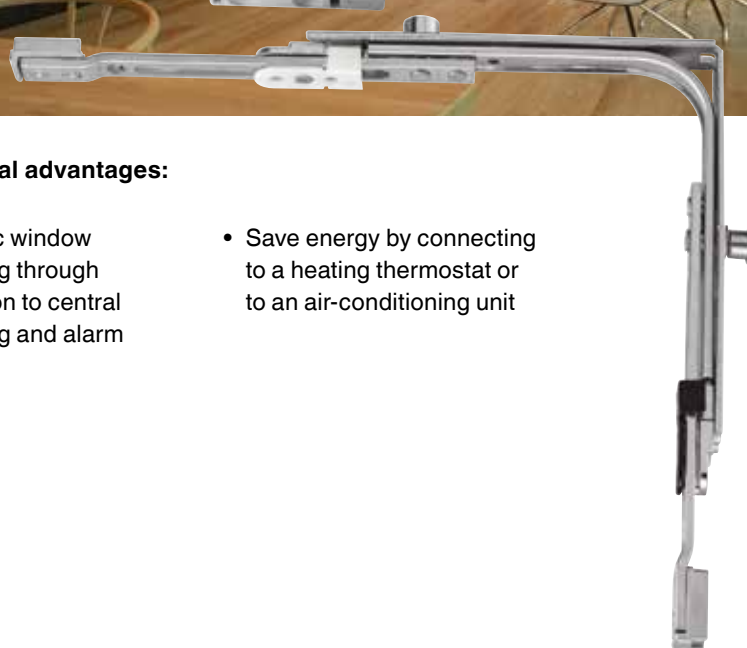



MACO TRONIC Electronic locking monitoring and heating control

VDS TESTED:

Locking monitoring up to level A, B, C, No. G 111028

Combined opening and lock monitoring up to level A, B No. G 111503

Opening monitoring class B and acc. to EN 50131-2-6 grade 2

- Automatic window monitoring through connection to the monitoring or alarm system.
By coupling to the fitting, the alarm system is not activated until the fitting is locked (not merely leant against the frame).
- The connection to central display signals which windows are open in a building (tilted windows are also deemed open for insurance claims) or closed.
- Save energy by connecting to a heating thermostat or to an air-conditioning unit. When the window is open, the heating automatically switches off.

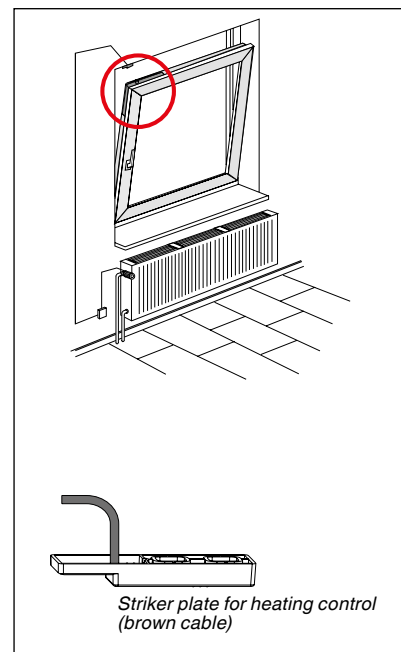
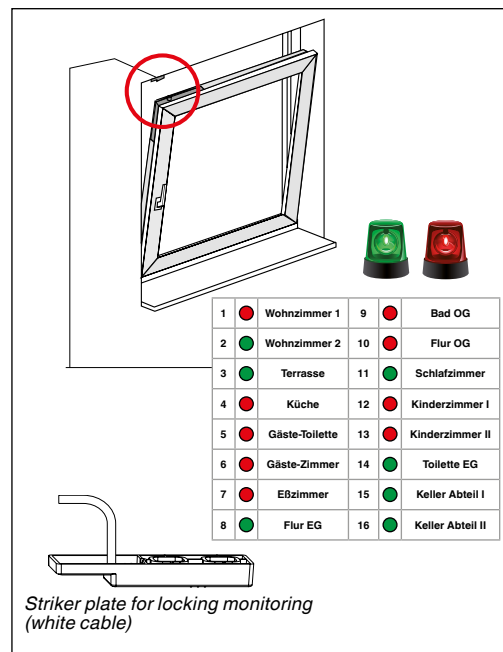

Monitoring or alarm system

Locking monitoring + heating control

All safety-relevant components are marked red!

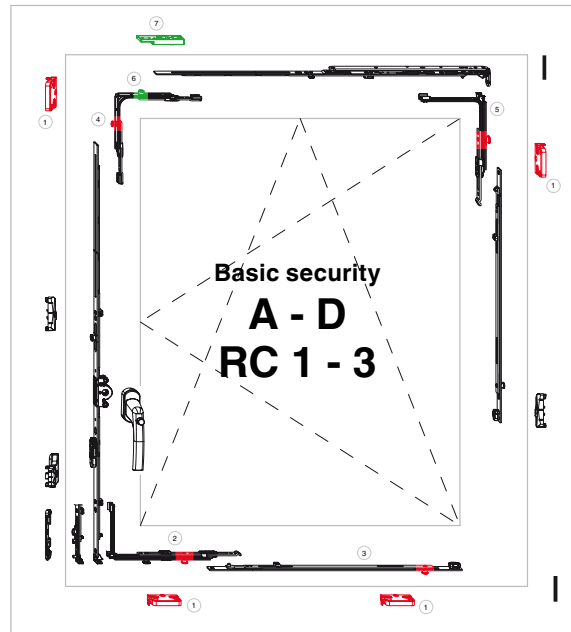

- 1 4 security strikers
- 2 1 horizontal extendible corner element with 1 i.S.
- 3 1 centre lock 1280 with 1 i.S.
- 4 1 corner element with 1 i.S.
- 5 1 vertical extendible corner element with 1 i.S.
- 6 1 cam with contact sensor
- 7 1 reed contact for lock monitoring

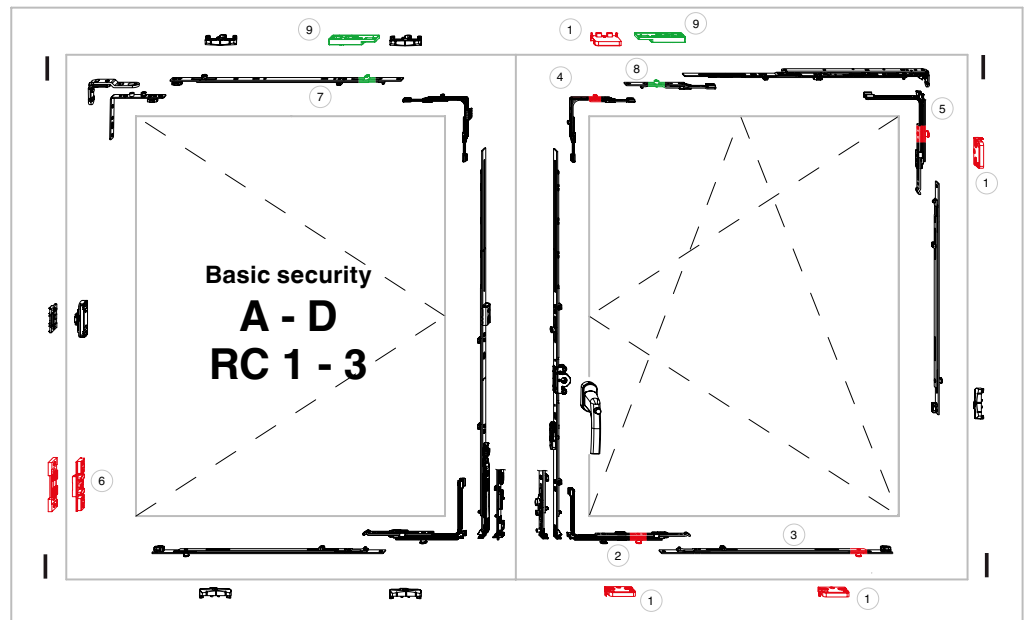

- 1 4 security strikers
- 2 1 horizontal extendible corner element with 1 i.S.
- 3 1 centre lock 1280 with 1 i.S.
- 4 1 corner element with 2 i.S.
- 5 1 vertical extendible corner element with 1 i.S.
- 6 1 turn-only hinge safety device
- 7 1 cam with contact sensor
- 8 1 extendible faceplate extension 140 with contact sensor.
- 9 2 reed contacts for lock monitoring

Locking monitoring + heating control

All safety-relevant components are marked red!

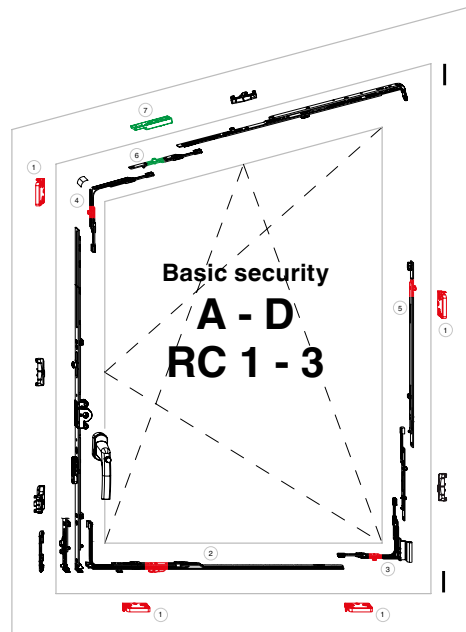

VdS tested!

- 1 4 security strikers
- 2 1 horizontal corner element for arched windows with 1 i.S.
- 3 1 corner support i.S.
- 4 1 top end piece for arched windows 1 i.S.
- 5 1 scissor stay for arched i. S. windows
- 6 1 extendible faceplate 140 with contact sensor.
- 7 1 reed contact for lock monitoring

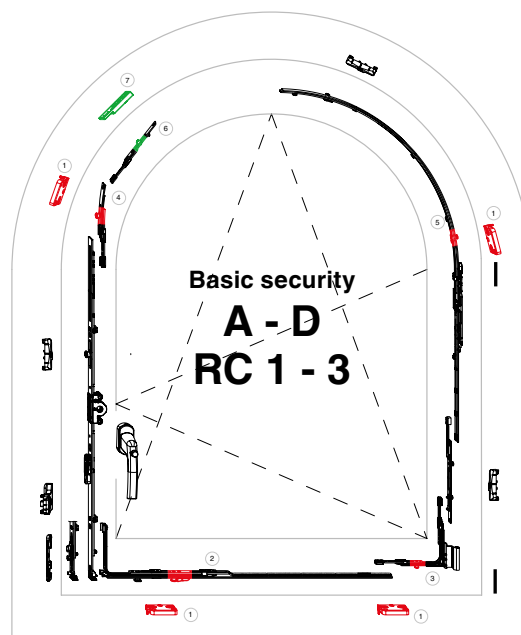

VdS tested!

- 1 4 security strikers
- 2 1 extendible corner element for pitched windows with 1 i.S.
- 3 1 corner support i.S.
- 4 1 corner element for pitched windows with 1 i.S.
- 5 1 centre lock 1280 with 1 i.S.
- 6 1 extendible faceplate 140 with contact sensor.
- 7 1 reed contact for lock monitoring



MACO TRONIC

Electronic lock and tilt monitoring



- A tilted window is signalled as closed.
- It is possible to ventilate without alarm, e.g. bedroom or lavatory.
- The alarm is issued when the window sash is out of the frame.

CAUTION:
Caution: tilt monitoring is not VdS approved!

Lock and tilt monitoring

All safety-relevant components are marked red!

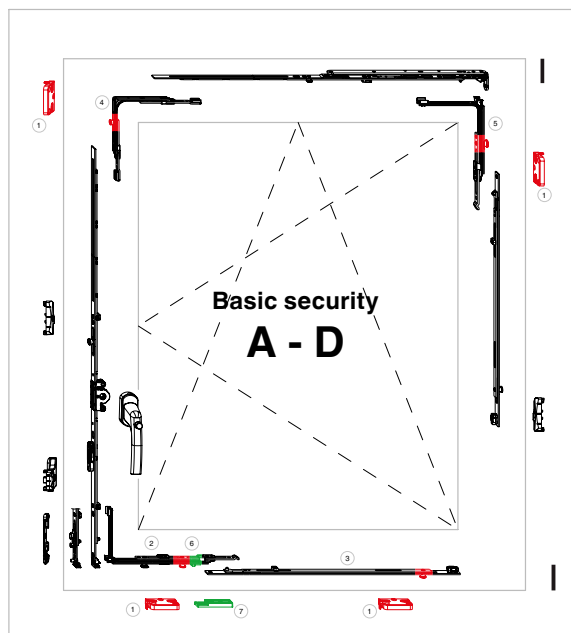

A tilted window is signalled as closed.

It is possible to ventilate without alarm, e.g. bedroom or lavatory. The alarm is issued when the window sash is out of the frame.

Caution: not VdS approved!

- 1 4 security strikers
- 2 1 horizontal extendible corner element with 1 i.S.
- 3 1 centre lock 1280 with 1 i.S.
- 4 1 corner element with 1 i.S.
- 5 1 vertical extendible corner element with 1 i.S.
- 6 1 adapter with contact sensor
- 7 1 reed contact for lock monitoring

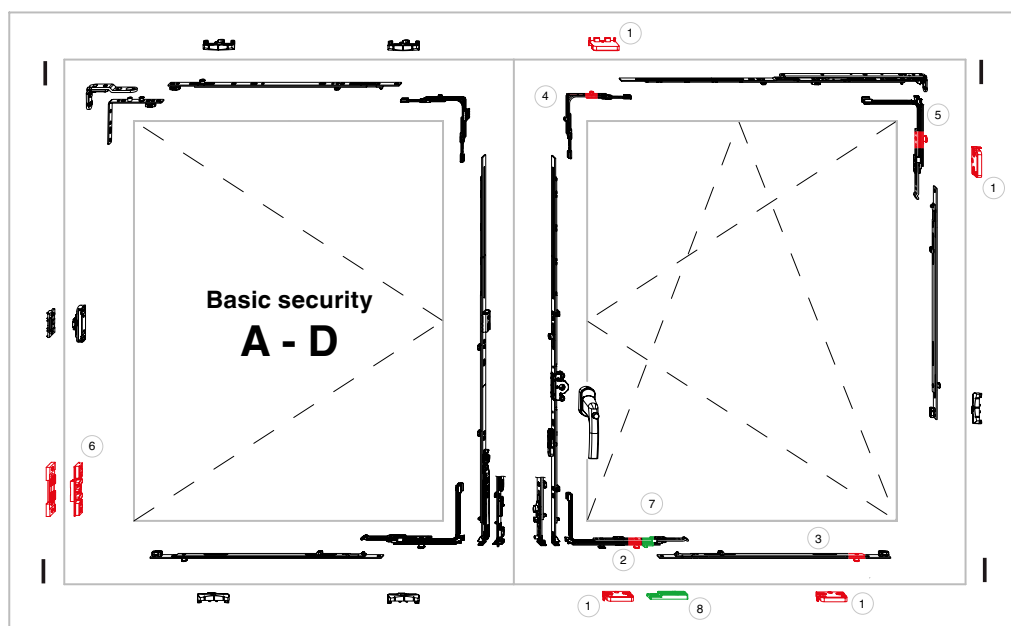

- 1 4 security strikers
- 2 1 horizontal extendible corner element with 1 i.S.
- 3 1 centre lock 1280 with 1 i.S.
- 4 1 corner element with 2 i.S.
- 5 1 vertical extendible corner element with 1 i.S.
- 6 1 turn-only hinge safety device
- 7 1 adapter with contact sensor
- 8 1 reed contact for lock monitoring

Lock and tilt monitoring

All safety-relevant components are marked red!

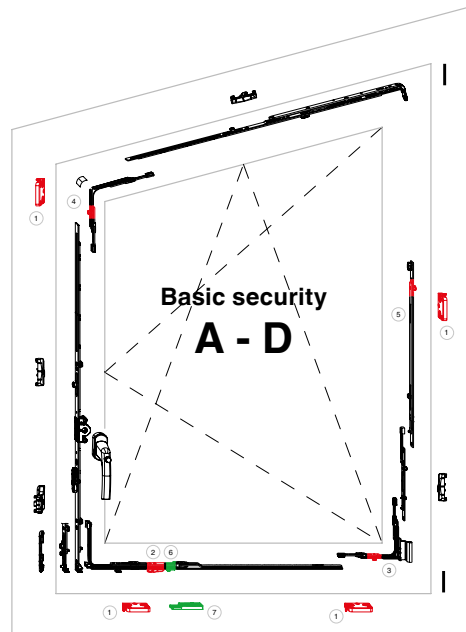

Caution:
not VdS approved!

- 1 4 security strikers
- 2 1 horizontal corner element for arched windows with 1 i.S.
- 3 1 corner support i.S.
- 4 1 top end piece for arched windows 1 i.S.
- 5 1 scissor stay for arched i. S. windows
- 6 1 adapter with contact sensor
- 7 1 reed contact for lock monitoring

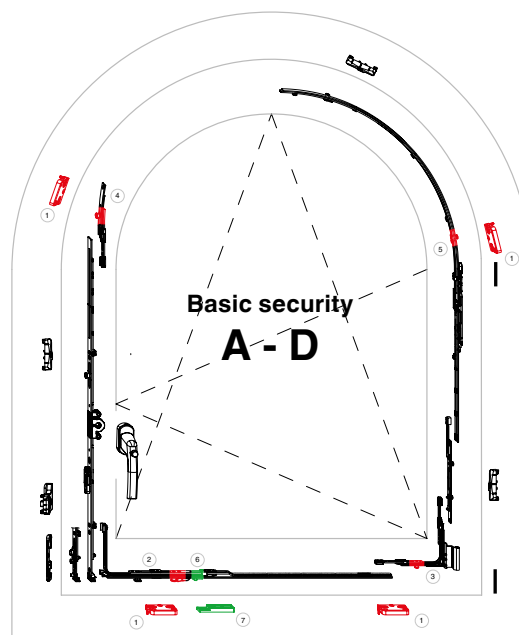

Caution:
not VdS approved!

- 1 4 security strikers
- 2 1 extendible corner element for pitched windows with 1 i.S.
- 3 1 corner support i.S.
- 4 1 corner element for pitched windows with 1 i.S.
- 5 1 centre lock 1280 with 1 i.S.
- 6 1 adapter with contact sensor
- 7 1 reed contact for lock monitoring

TECHNOLOGY IN MOTION



MAYER & CO
BESCHLÄGE GMBH

Alpenstraße 173
A-5020 Salzburg

Tel.: +43 662 6196-0
E-Mail: maco@maco.eu
www.maco.eu

Satisfied?

We appreciate your
feedback@maco.eu

Order No. 756892EN - Date: June 2012
date changed: February 2017
All rights reserved and subject to change.

This print document is revised regularly.
The latest version is available at
<http://www.maco.eu/sites/assets/MacoDocs/756892/756892en.pdf>
or scan the QR code.

